



Argonne Training Program on Extreme-Scale Computing

TAU Performance System

Sameer Shende

Director, Performance Research Laboratory, University of Oregon

St. Charles Amphitheater D L201, Q Center, St. Charles, IL (USA)
August 7, 2019

TAU Performance System[®]

- Parallel performance framework and toolkit
 - Supports all HPC platforms, compilers, runtime system
 - Provides portable instrumentation, measurement, analysis

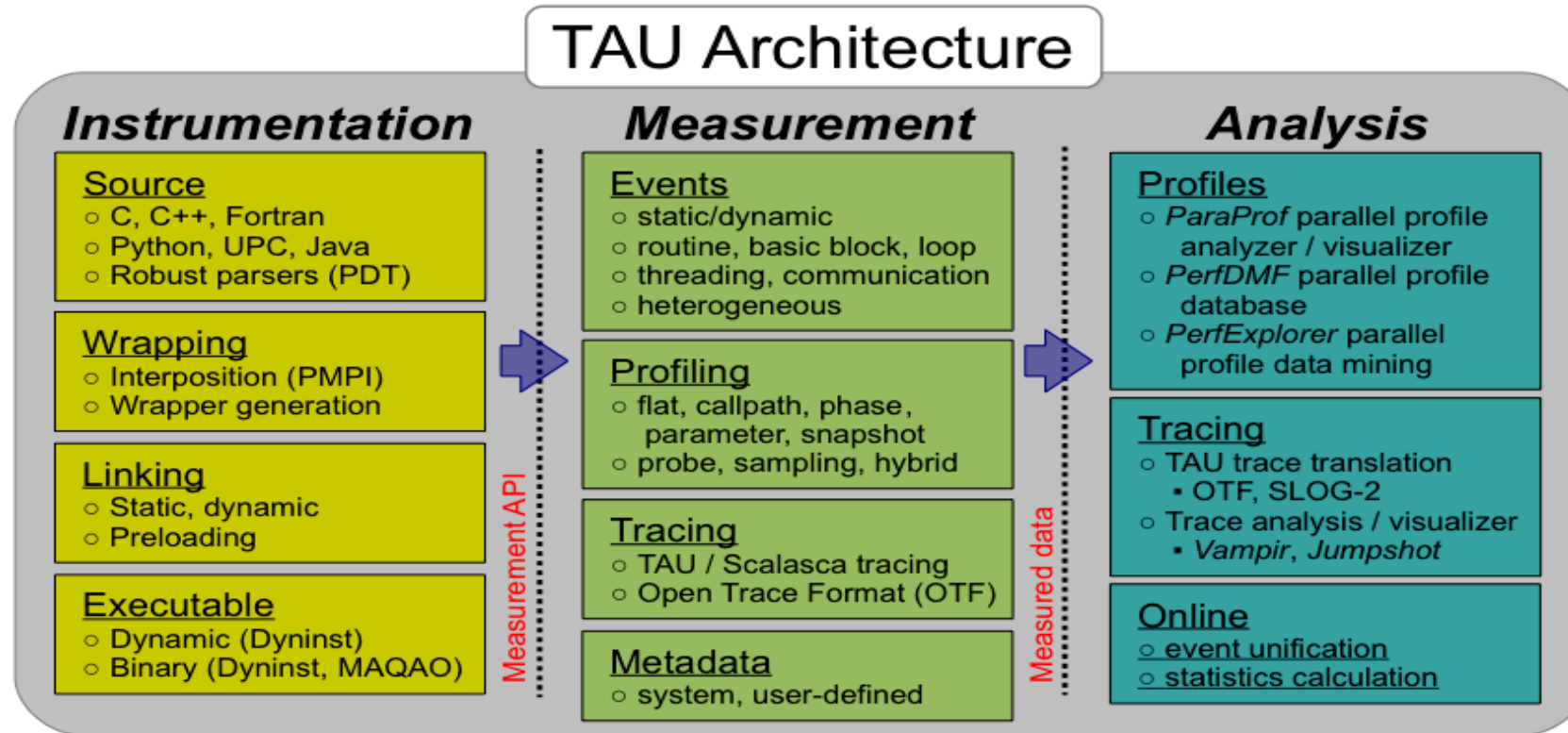
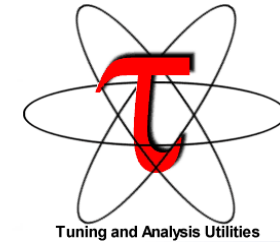

TAU Performance System

- Instrumentation
 - Fortran, C++, C, UPC, Java, Python, Chapel, Spark
 - Automatic instrumentation
- Measurement and analysis support
 - MPI, OpenSHMEM, ARMCI, PGAS, DMAPP
 - pthreads, OpenMP, OMPT interface, hybrid, other thread models
 - GPU, CUDA, OpenCL, OpenACC
 - Parallel profiling and tracing
- Analysis
 - Parallel profile analysis (ParaProf), data mining (PerfExplorer)
 - Performance database technology (TAUdb)
 - 3D profile browser

Application Performance Engineering using TAU

- How much time is spent in each application routine and outer *loops*? Within loops, what is the contribution of each *statement*? What is the time spent in OpenMP loops?
- How many instructions are executed in these code regions?
Floating point, Level 1 and 2 *data cache misses*, hits, branches taken? What is the extent of vectorization for loops on Intel MIC?
- What is the memory usage of the code? When and where is memory allocated/de-allocated? Are there any memory leaks? What is the memory footprint of the application? What is the memory high water mark?
- How much energy does the application use in Joules? What is the peak power usage?
- What are the I/O characteristics of the code? What is the peak read and write *bandwidth* of individual calls, total volume?
- What is the contribution of each *phase* of the program? What is the time wasted/spent waiting for collectives, and I/O operations in Initialization, Computation, I/O phases?
- How does the application *scale*? What is the efficiency, runtime breakdown of performance across different core counts?

Instrumentation

Add hooks in the code to perform measurements

- **Source instrumentation using a preprocessor**
 - Add timer start/stop calls in a copy of the source code.
 - Use Program Database Toolkit (PDT) for parsing source code.
 - Requires recompiling the code using TAU shell scripts (tau_cc.sh, tau_f90.sh)
 - Selective instrumentation (filter file) can reduce runtime overhead and narrow instrumentation focus.
- **Compiler-based instrumentation**
 - Use system compiler to add a special flag to insert hooks at routine entry/exit.
 - Requires recompiling using TAU compiler scripts (tau_cc.sh, tau_f90.sh...)
- **Runtime preloading of TAU's Dynamic Shared Object (DSO)**
 - No need to recompile code! Use **aprun tau_exec ./app** with options.
 - Requires dynamic executable (link using **-dynamic** on Theta).

Profiling and Tracing

Profiling

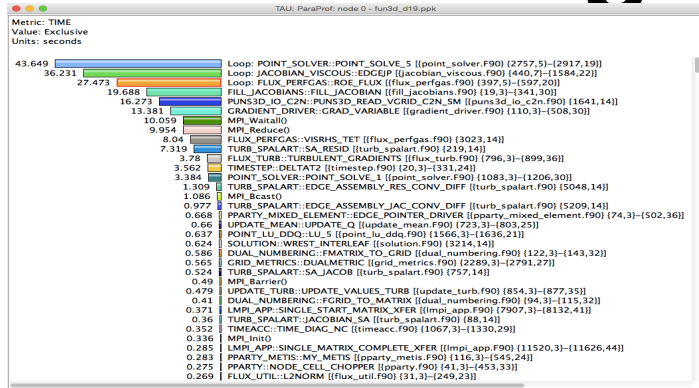

- Profiling shows you how much (total) time was spent in each routine
- Profiling and tracing

Profiling shows you how much (total) time was spent in each routine

Tracing shows you when the events take place on a timeline

Tracing

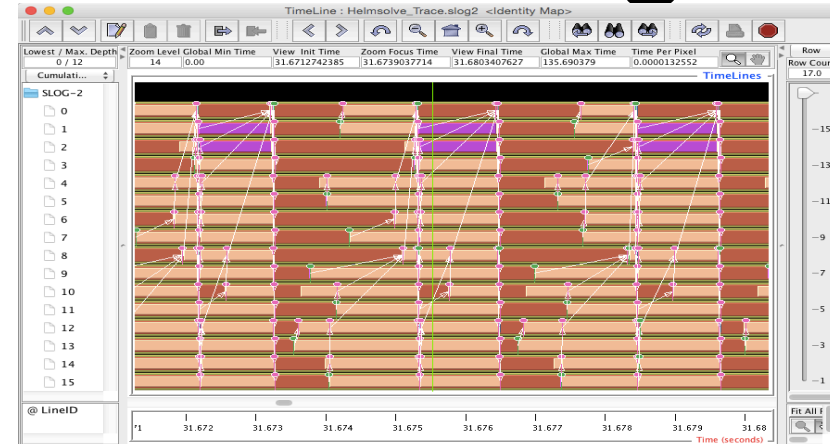

- Tracing shows you when the events take place on a timeline

Inclusive vs. Exclusive values

- Inclusive
 - Information of all sub-elements aggregated into single value
- Exclusive
 - Information cannot be subdivided further

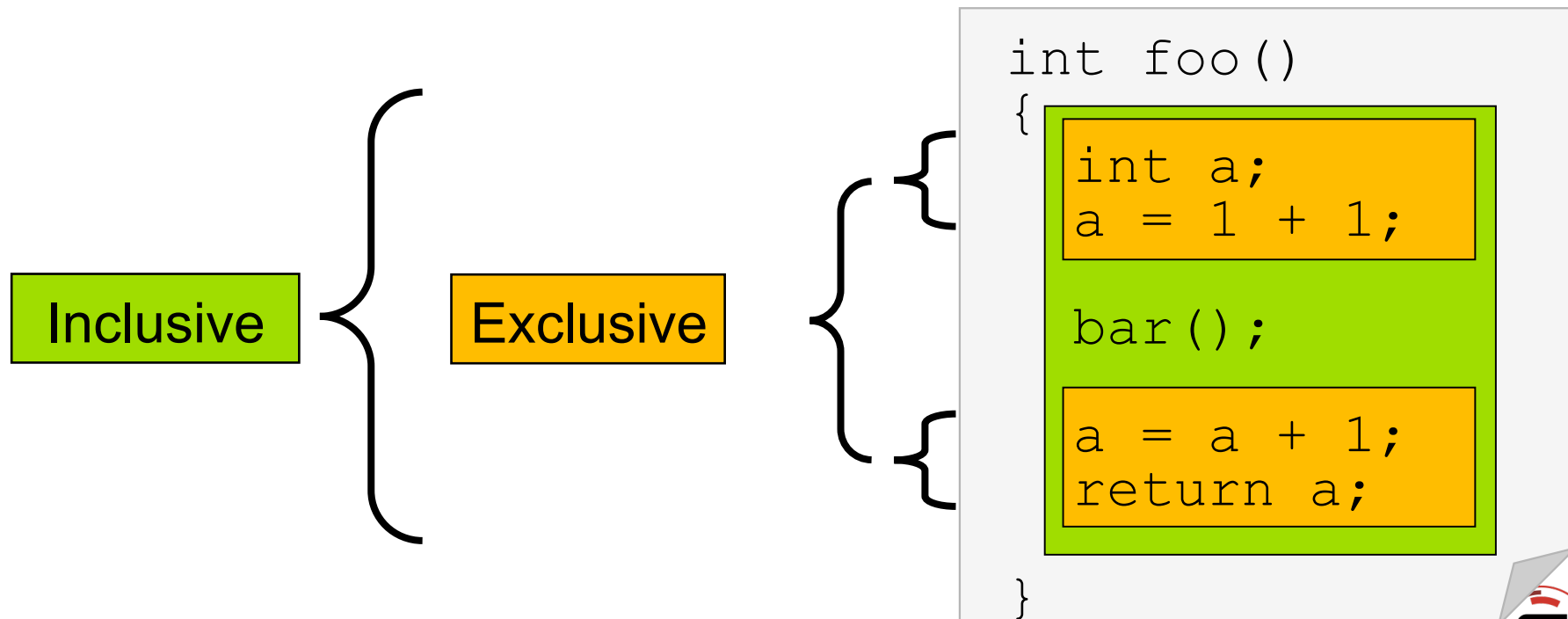

Performance Data Measurement

Direct via Probes

```
Call START('potential')  
// code  
Call STOP('potential')
```

- Exact measurement
- Fine-grain control
- Calls inserted into code

Indirect via Sampling

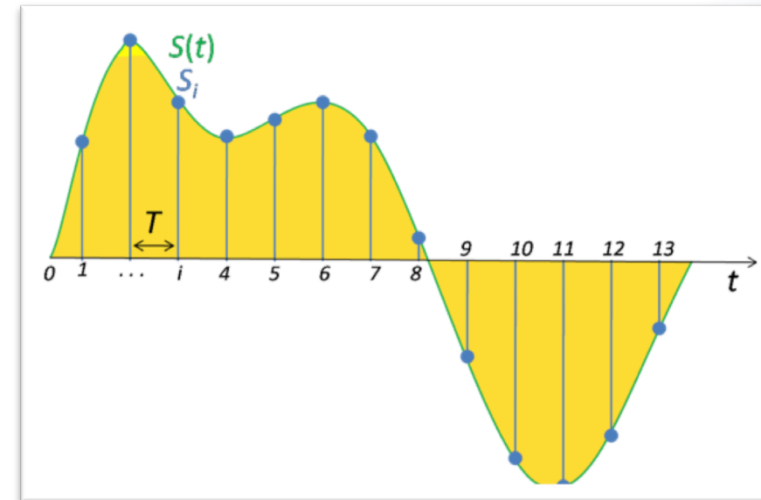

- No code modification
- Minimal effort
- Relies on debug symbols (**-g**)

Sampling

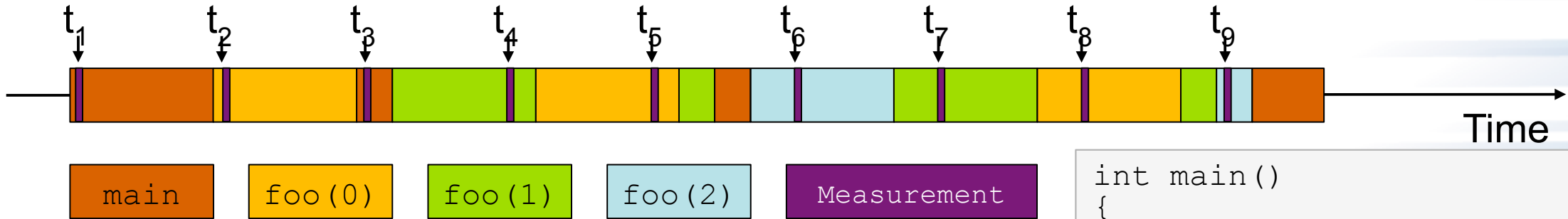

- Running program is periodically interrupted to take measurement
 - Timer interrupt, OS signal, or HWC overflow
 - Service routine examines return-address stack
 - Addresses are mapped to routines using symbol table information
- Statistical inference of program behavior
 - Not very detailed information on highly volatile metrics
 - Requires long-running applications
- Works with unmodified executables

```
int main()
{
    int i;

    for (i=0; i < 3; i++)
        foo(i);

    return 0;
}

void foo(int i)
{
    if (i > 0)
        foo(i - 1);
}
```

Instrumentation

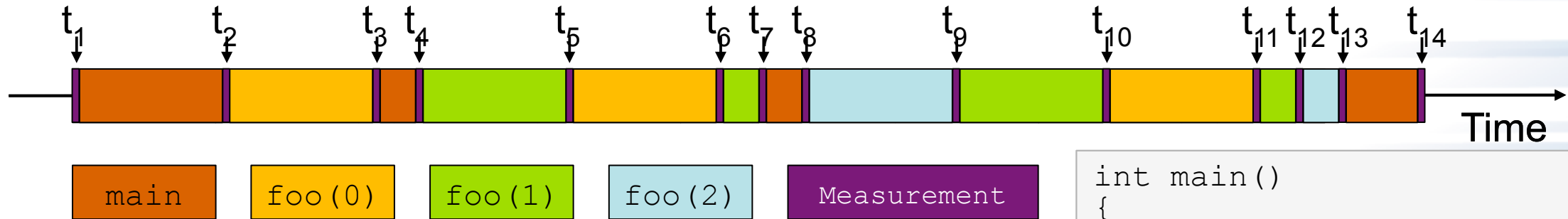

- Measurement code is inserted such that every event of interest is captured directly
 - Can be done in various ways
- Advantage:
 - Much more detailed information
- Disadvantage:
 - Processing of source-code / executable necessary
 - Large relative overheads for small functions

```
int main()
{
    int i;
    Start("main");
    for (i=0; i < 3; i++)
        foo(i);
    Stop ("main");
    return 0;
}

void foo(int i)
{
    Start("foo");
    if (i > 0)
        foo(i - 1);
    Stop ("foo");
}
```

Using TAU's Runtime Preloading Tool: tau_exec

- Preload a wrapper that intercepts the runtime system call and substitutes with another
 - MPI
 - OpenMP
 - POSIX I/O
 - Memory allocation/deallocation routines
 - Wrapper library for an external package
- No modification to the binary executable!
- Enable other TAU options (communication matrix, OTF2, event-based sampling)

TAU's support for OpenMP Tools Interface

- OpenMP Tools Interface (OMPT)
 - Replacement LLVM/Intel OpenMP library
 - TR4 – Intel 18
 - TR6
 - OMPT support without preloading any wrapper interposition library
 - TR7 – Intel 19.0.1
 - V5 - Intel 19.0.3+



Demo!



Simplifying TAU's usage (tau_exec)

- Uninstrumented execution
 - % aprun -n 64 ./a.out
- Track MPI performance
 - % aprun -n 64 **tau_exec** ./a.out
- Use event based sampling (compile with -g)
 - % aprun -n 64 **tau_exec -ebs** ./a.out
 - Also `-ebs_source=<PAPI_COUNTER> -ebs_period=<overflow_count> -ebs_resolution=[file|function|line]` (line is default)
- Track POSIX I/O and MPI performance (MPI enabled by default)
 - % aprun -n 64 **tau_exec -T** mpi,pdt,papi **-io** ./a.out
- Track OpenMP runtime routines
 - % aprun -n 64 **tau_exec -T** ompt,**v5**,pdt,mpi **-ompt** ./a.out
- Track memory operations
 - % export TAU_TRACK_MEMORY_LEAKS=1
 - % aprun -n 64 **tau_exec -memory_debug** ./a.out (bounds check)
- Load wrapper interposition library
 - % aprun -n 64 **tau_exec -loadlib=<path/libwrapper.so>** ./a.out

RUNTIME PRELOADING

- Injects TAU DSO in the executing application
- Requires dynamic executables
- We must compile with `-dynamic -g`
- Use `tau_exec` while launching the application

Copy the workshop tarball

- Setup preferred program environment compilers
 - Default set Intel Compilers with Intel MPI. You must compile with **–dynamic -g**

```
% module load tau; module load intel/19.0.3.199
% tar zxf /soft/perfutils/tau/workshop.tgz
% cd workshop/MZ-NPB3.3-MPI; cat README
% make clean
% make suite
% cd bin
In a second window:
% qsub -I -n 1 -A ATPESC2019 -q training -t 50
% cd bin; module unload darshan; module load intel/19.0.3.199; module load tau
% export OMP_NUM_THREADS=4
% aprun -n 16 ./bt-mz.B.16
% export TAU_OMPT_SUPPORT_LEVEL=full; export TAU_OMPT_RESOLVE_ADDRESS_EAGERLY=1
% aprun -n 16 tau_exec -T ompt,v5,mpi,pdt -ompt ./bt-mz.B.16
% paraprof --pack ex1.ppk
In the first window:
% paraprof ex1.ppk &
```

NPB-MZ-MPI Suite

- The NAS Parallel Benchmark suite (MPI+OpenMP version)

- Available from:

<http://www.nas.nasa.gov/Software/NPB>

- 3 benchmarks in Fortran77
 - Configurable for various sizes & classes

- ```
% ls
bin/ common/ jobscript/ Makefile README.install SP-MZ/
BT-MZ/ config/ LU-MZ/ README README.tutorial sys/
```

- Subdirectories contain source code for each benchmark
  - plus additional configuration and common code
- The provided distribution has already been configured for the tutorial, such that it's ready to “make” one or more of the benchmarks and install them into a (tool-specific) “bin” subdirectory

# NPB-MZ-MPI / BT (Block Tridiagonal Solver)

- What does it do?
  - Solves a discretized version of the unsteady, compressible Navier-Stokes equations in three spatial dimensions
  - Performs 200 time-steps on a regular 3-dimensional grid
- Implemented in 20 or so Fortran77 source modules
- Uses MPI & OpenMP in combination
  - 16 processes each with 4 threads should be reasonable
  - bt-mz.B.16 should take around 1 minute

# NPB-MZ-MPI / BT: config/make.def

```
SITE- AND/OR PLATFORM-SPECIFIC DEFINITIONS.
#
#-----
#-----
Configured for generic MPI with GCC compiler
#-----
#OPENMP = -fopenmp # GCC compiler
OPENMP = -qopenmp -extend-source # Intel compiler

...
#-----
The Fortran compiler used for MPI programs
#-----

F77 = ftn # Intel compiler

Alternative variant to perform instrumentation

...

```

Default (no instrumentation)

# Building an NPB-MZ-MPI Benchmark

```
% make
=====
= NAS PARALLEL BENCHMARKS 3.3 =
= MPI+OpenMP Multi-Zone Versions =
= F77 =
=====

To make a NAS multi-zone benchmark type

 make <benchmark-name> CLASS=<class> NPROCS=<nprocs>

where <benchmark-name> is "bt-mz", "lu-mz", or "sp-mz"
 <class> is "S", "W", "A" through "F"
 <nprocs> is number of processes

[...]
```

```

* Custom build configuration is specified in config/make.def *
* Suggested tutorial exercise configuration for HPC systems: *
* make bt-mz CLASS=C NPROCS=8 *

```

- Type “make” for instructions
- make suite



# TAU Source Instrumentation

- Edit `config/make.def` to adjust build configuration
  - Uncomment specification of compiler/linker: `F77 = tau_f77.sh` or use `make F77=tau_f77.sh`
- Make clean and build new tool-specific executable
- Change to the directory containing the new executable before running it with the desired tool configuration

# tau\_exec

```
$ tau_exec

Usage: tau_exec [options] [--] <exe> <exe options>

Options:
 -v Verbose mode
 -s Show what will be done but don't actually do anything (dryrun)
 -qsub Use qsub mode (BG/P only, see below)
 -io Track I/O
 -memory Track memory allocation/deallocation
 -memory_debug Enable memory debugger
 -cuda Track GPU events via CUDA
 -cupti Track GPU events via CUPTI (Also see env. variable TAU_CUPTI_API)
 -opencl Track GPU events via OpenCL
 -openacc Track GPU events via OpenACC (currently PGI only)
 -ompt Track OpenMP events via OMPT interface
 -armci Track ARMCI events via PARMCI
 -ebs Enable event-based sampling
 -ebs_period=<count> Sampling period (default 1000)
 -ebs_source=<counter> Counter (default itimer)
 -um Enable Unified Memory events via CUPTI
 -T <DISABLE,GNU,ICPC,MPI,OMPT,OPENMP,PAPI,PDT,PROFILE,PTHREAD,SCOREP,SERIAL> : Specify TAU tags
 -loadlib=<file.so> : Specify additional load library
 -XrunTAUsh-<options> : Specify TAU library directly
 -gdb Run program in the gdb debugger

Notes:
 Defaults if unspecified: -T MPI
 MPI is assumed unless SERIAL is specified
```

- **Tau\_exec** preloads the TAU wrapper libraries and performs measurements.

No need to recompile the application!

# tau\_exec Example (continued)

Example:

```
mpirun -np 2 tau_exec -T icpc,ompt,mpi -ompt ./a.out
aprun -n 2 tau_exec -io ./a.out
```

Example - event-based sampling with samples taken every 1,000,000 FP instructions

```
aprun -n 8 tau_exec -ebs -ebs_period=1000000 -ebs_source=PAPI_FP_INS ./ring
```

Examples - GPU:

```
tau_exec -T serial,cupti -cupti ./matmult (Preferred for CUDA 4.1 or later)
tau_exec -openacc ./a.out
tau_exec -T serial -opencl ./a.out (OPENCL)
mpirun -np 2 tau_exec -T mpi,cupti,papi -cupti -um ./a.out (Unified Virtual Memory in CUDA 6.0+)
```

qsub mode (IBM BG/Q only):

Original:

```
qsub -n 1 --mode smp -t 10 ./a.out
```

With TAU:

```
tau_exec -qsub -io -memory -- qsub -n 1 ... -t 10 ./a.out
```

Memory Debugging:

-memory option:

Tracks heap allocation/deallocation and memory leaks.

-memory\_debug option:

Detects memory leaks, checks for invalid alignment, and checks for array overflow. This is exactly like setting TAU\_TRACK\_MEMORY\_LEAKS=1 and TAU\_MEMDBG\_PROTECT\_ABOVE=1 and running with -memory

- tau\_exec can enable event based sampling while launching the executable using env **TAU\_SAMPLING=1** or tau\_exec **-ebs**

# Event Based Sampling with TAU

```
% cd MZ-NPB3.3-MPI; cat README
• % make clean;
% make suite
% cd bin
% qsub -I -n 1 -A ATPESC2019 -q training -t 50
% module unload darshan; module load intel tau
% export OMP_NUM_THREADS=4
% export TAU_OMPT_SUPPORT_LEVEL=full; export TAU_OMPT_RESOLVE_ADDRESS_EAGERLY=1
% aprun -n 16 tau_exec -T ompt,tr6 -ebs ./bt-mz.B.16
% On head node:
% module load tau
% paraprof
```

- Right Click on Node 0 and choose  
Show Thread Statistics Table

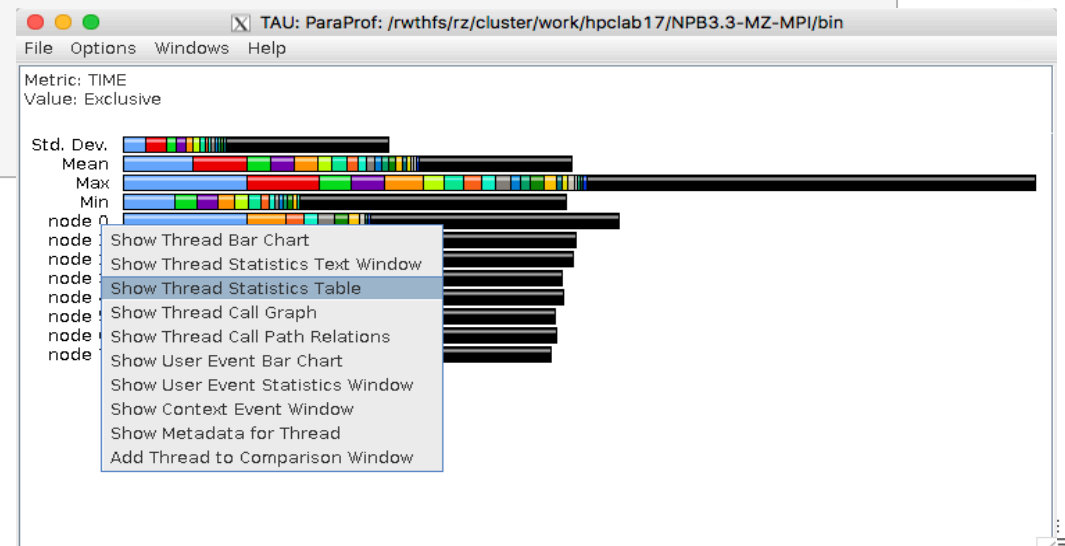

# How much data do you want?

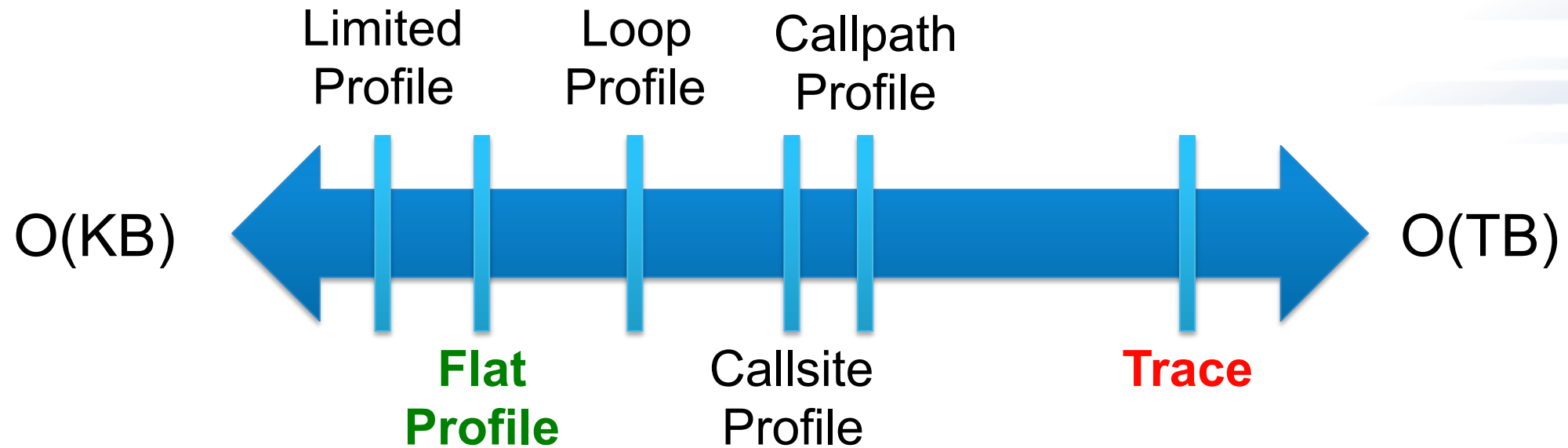

# Types of Performance Profiles

- **Flat** profiles
  - Metric (e.g., time) spent in an event
  - Exclusive/inclusive, # of calls, child calls, ...
- **Callpath** profiles
  - Time spent along a calling path (edges in callgraph)
  - “*main=> f1 => f2 => MPI\_Send*”
  - Set the **TAU\_CALLPATH** and **TAU\_CALLPATH\_DEPTH** environment variables
- **Callsite** profiles
  - Time spent along in an event at a given source location
  - Set the **TAU\_CALLSITE** environment variable
- **Phase** profiles
  - Flat profiles under a phase (nested phases allowed)
  - Default “main” phase
  - Supports static or dynamic (e.g. per-iteration) phases

# ParaProf Profile Browser

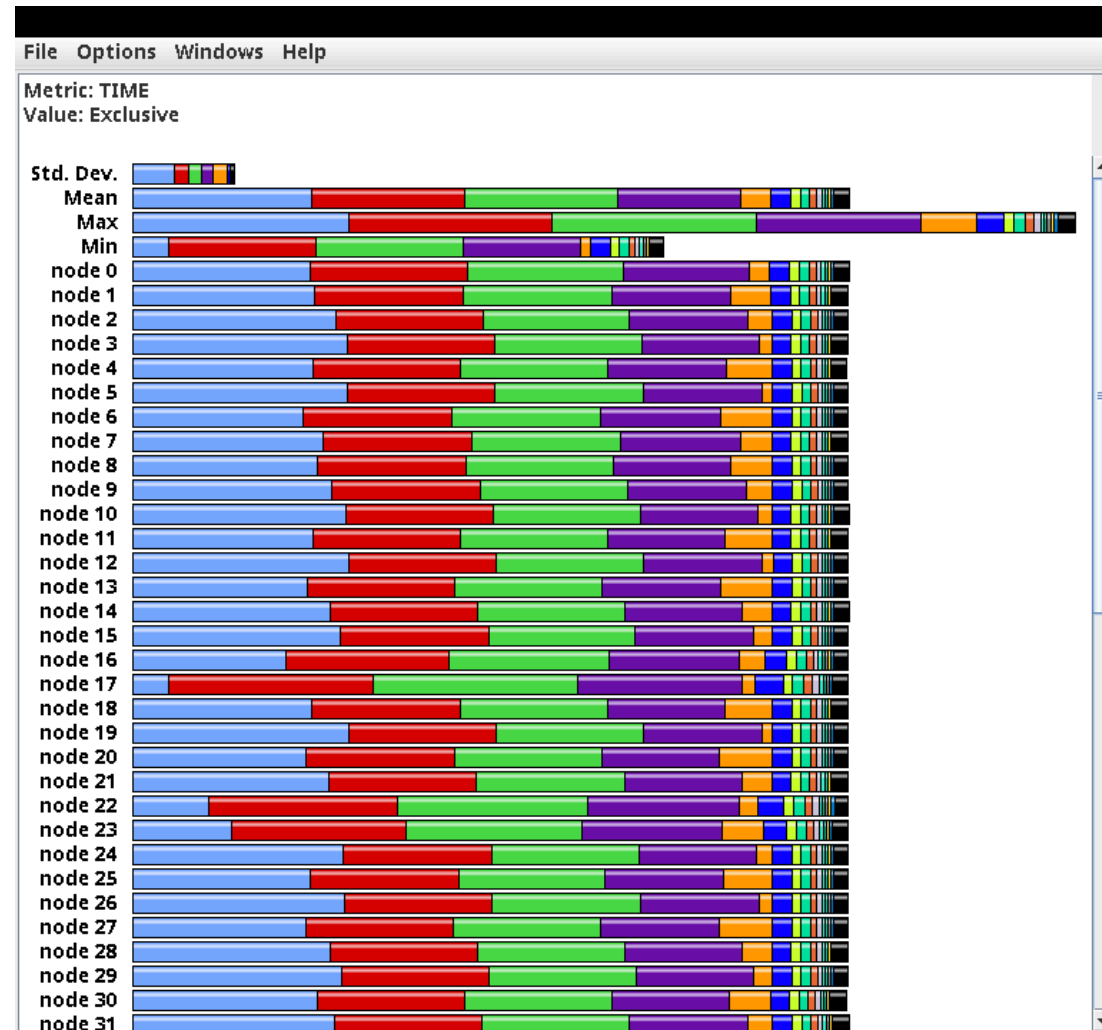

% paraprof

# ParaProf Profile Browser

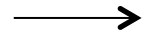
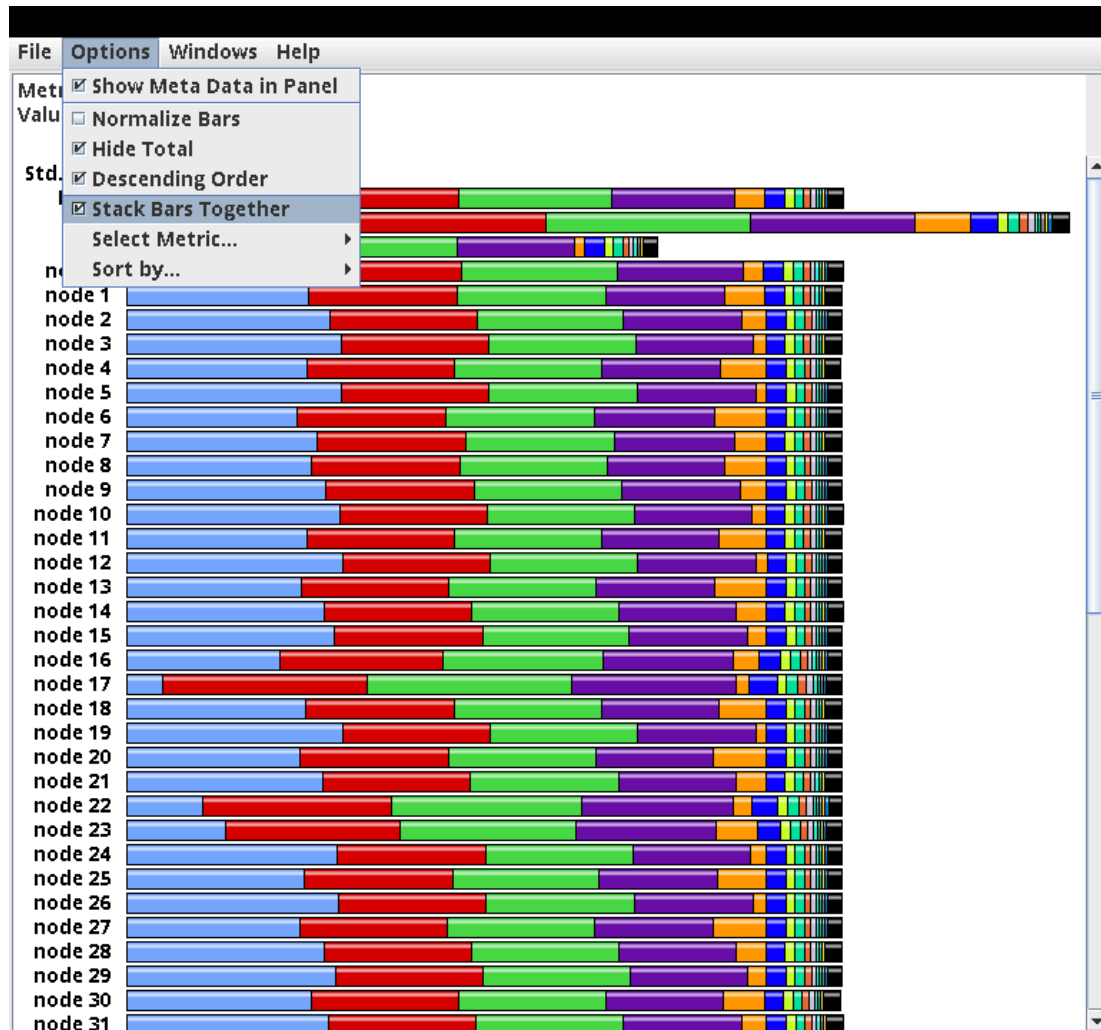



# TAU – Flat Profile

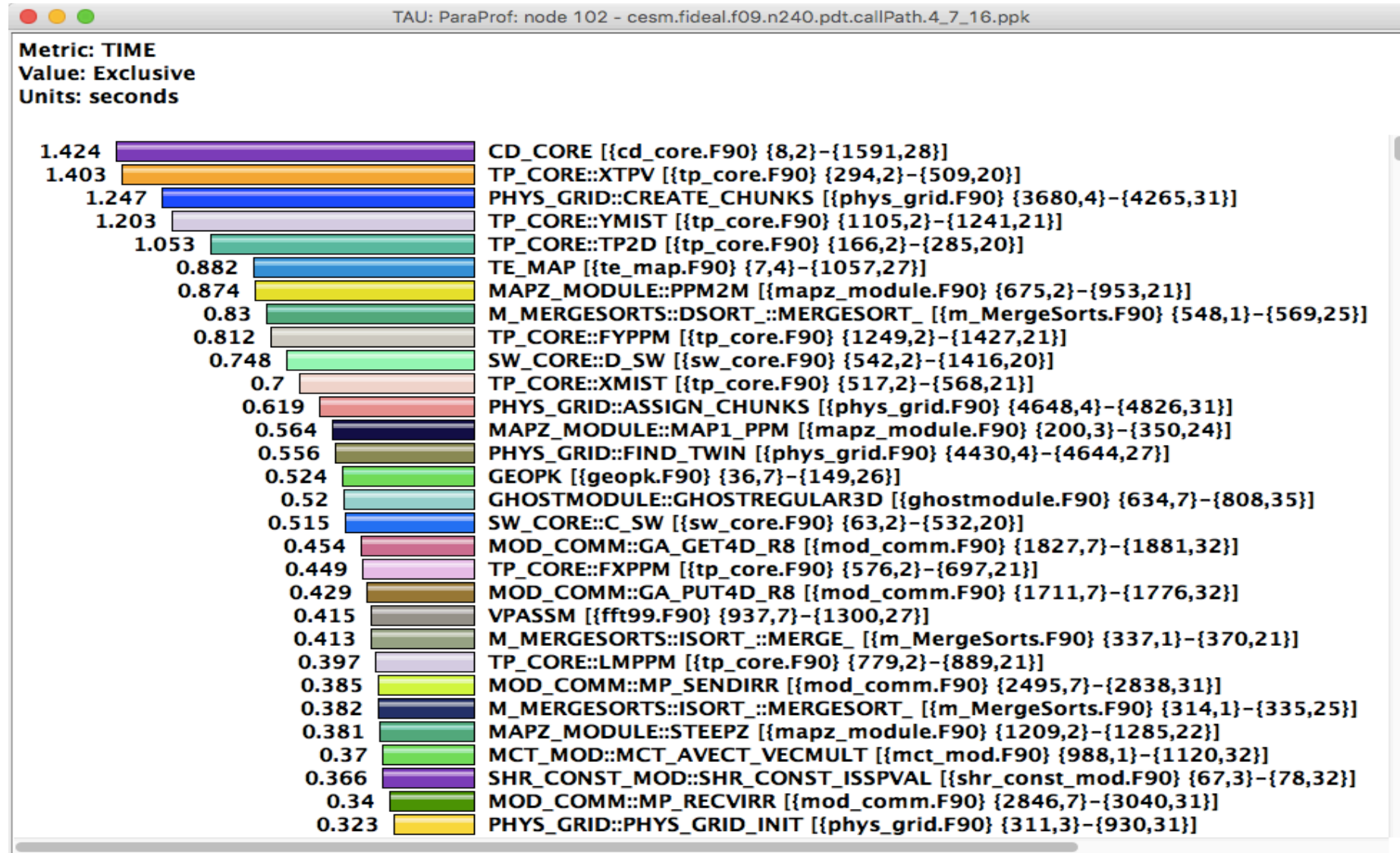

# ParaProf

- Click on Columns:
- to sort by incl time
- Open binvcrhs
- Click on Sample

| Name                                                                             | Exclusive TIME | Inclusive TIME | Calls | Child Calls |
|----------------------------------------------------------------------------------|----------------|----------------|-------|-------------|
| .TAU application                                                                 | 9.167          | 9.368          | 1     | 2,432       |
| [CONTEXT] .TAU application                                                       | 0              | 9.019          | 901   | 0           |
| [SUMMARY] binvcrhs_ [{} /rwthfs/rz/cluster/work/hpclub17/NPB3.3-MZ-MPI/BT-MZ/    | 2.89           | 2.89           | 288   | 0           |
| [SUMMARY] matmul_sub_ [{} /rwthfs/rz/cluster/work/hpclub17/NPB3.3-MZ-MPI/BT      | 1.27           | 1.27           | 127   | 0           |
| [SUMMARY] x_solve_ [{} /rwthfs/rz/cluster/work/hpclub17/NPB3.3-MZ-MPI/BT-MZ/x    | 1.16           | 1.16           | 116   | 0           |
| [SUMMARY] z_solve_ [{} /rwthfs/rz/cluster/work/hpclub17/NPB3.3-MZ-MPI/BT-MZ/z    | 1.08           | 1.08           | 108   | 0           |
| [SUMMARY] y_solve_ [{} /rwthfs/rz/cluster/work/hpclub17/NPB3.3-MZ-MPI/BT-MZ/y    | 1.08           | 1.08           | 108   | 0           |
| [SUMMARY] compute_rhs_ [{} /rwthfs/rz/cluster/work/hpclub17/NPB3.3-MZ-MPI/B      | 0.83           | 0.83           | 83    | 0           |
| [SUMMARY] matvec_sub_ [{} /rwthfs/rz/cluster/work/hpclub17/NPB3.3-MZ-MPI/BT      | 0.49           | 0.49           | 49    | 0           |
| [SUMMARY] lhsinit_ [{} /rwthfs/rz/cluster/work/hpclub17/NPB3.3-MZ-MPI/BT-MZ/in   | 0.08           | 0.08           | 8     | 0           |
| [SAMPLE] add_ [{} /rwthfs/rz/cluster/work/hpclub17/NPB3.3-MZ-MPI/BT-MZ/add.f}    | 0.05           | 0.05           | 5     | 0           |
| [SUMMARY] binvrhs_ [{} /rwthfs/rz/cluster/work/hpclub17/NPB3.3-MZ-MPI/BT-MZ/e    | 0.04           | 0.04           | 4     | 0           |
| [SUMMARY] exact_solution_ [{} /rwthfs/rz/cluster/work/hpclub17/NPB3.3-MZ-MPI/    | 0.02           | 0.02           | 2     | 0           |
| [SAMPLE] copy_x_face [{} /rwthfs/rz/cluster/work/hpclub17/NPB3.3-MZ-MPI/BT-MZ    | 0.01           | 0.01           | 1     | 0           |
| [SUMMARY] exact_rhs_ [{} /rwthfs/rz/cluster/work/hpclub17/NPB3.3-MZ-MPI/BT-M     | 0.01           | 0.01           | 1     | 0           |
| [SAMPLE] initialize_ [{} /rwthfs/rz/cluster/work/hpclub17/NPB3.3-MZ-MPI/BT-MZ/in | 0.009          | 0.009          | 1     | 0           |
| MPI_Init_thread()                                                                | 0.155          | 0.155          | 1     | 0           |
| MPI_Finalize()                                                                   | 0.022          | 0.022          | 1     | 0           |
| MPI_Waitall()                                                                    | 0.018          | 0.018          | 804   | 0           |
| MPI_Irecv()                                                                      | 0.004          | 0.004          | 804   | 0           |
| MPI_Isend()                                                                      | 0.001          | 0.001          | 804   | 0           |
| MPI_Comm_split()                                                                 | 0              | 0              | 1     | 0           |
| MPI_Bcast()                                                                      | 0              | 0              | 9     | 0           |
| MPI_Reduce()                                                                     | 0              | 0              | 3     | 0           |
| MPI_Barrier()                                                                    | 0              | 0              | 2     | 0           |
| MPI_Comm_size()                                                                  | 0              | 0              | 1     | 0           |
| MPI_Comm_rank()                                                                  | 0              | 0              | 2     | 0           |

# ParaProf

TAU: ParaProf: Statistics for: node 0 - /rwthfs/rz/cluster/work/hpclab17/NPB3.3-MZ-MPI/bin

File Options Windows Help

| Name                                                                                          | Exclusive TIME | Inclusive TIME | Calls | Child Calls |
|-----------------------------------------------------------------------------------------------|----------------|----------------|-------|-------------|
| .TAU application                                                                              | 9.167          | 9.368          | 1     | 2,432       |
| [CONTEXT] .TAU application                                                                    | 0              | 9.019          | 901   | 0           |
| [SUMMARY] binvcrhs_ [/{rwthfs/rz/cluster/work/hpclab17/NPB3.3-MZ-MPI/BT-MZ/solve_sub.f}]      | 2.89           | 2.89           | 288   | 0           |
| [SAMPLE] binvcrhs_ [/{rwthfs/rz/cluster/work/hpclab17/NPB3.3-MZ-MPI/BT-MZ/solve_sub.f}] {228} | 0.14           | 0.14           | 14    | 0           |
| [SAMPLE] binvcrhs_ [/{rwthfs/rz/cluster/work/hpclab17/NPB3.3-MZ-MPI/BT-MZ/solve_sub.f}]       | 0.09           | 0.09           | 9     | 0           |
| [SAMPLE] binvcrhs_ [/{rwthfs/rz/cluster/work/hpclab17/NPB3.3-MZ-MPI/BT-MZ/solve_sub.f}]       | 0.09           | 0.09           | 9     | 0           |
| [SAMPLE] binvcrhs_ [/{rwthfs/rz/cluster/work/hpclab17/NPB3.3-MZ-MPI/BT-MZ/solve_sub.f}]       | 0.06           | 0.06           | 6     | 0           |
| [SAMPLE] binvcrhs_ [/{rwthfs/rz/cluster/work/hpclab17/NPB3.3-MZ-MPI/BT-MZ/solve_sub.f}]       | 0.06           | 0.06           | 6     | 0           |
| [SAMPLE] binvcrhs_ [/{rwthfs/rz/cluster/work/hpclab17/NPB3.3-MZ-MPI/BT-MZ/solve_sub.f}]       | 0.06           | 0.06           | 6     | 0           |
| [SAMPLE] binvcrhs_ [/{rwthfs/rz/cluster/work/hpclab17/NPB3.3-MZ-MPI/BT-MZ/solve_sub.f}]       | 0.06           | 0.06           | 6     | 0           |
| [SAMPLE] binvcrhs_ [/{rwthfs/rz/cluster/work/hpclab17/NPB3.3-MZ-MPI/BT-MZ/solve_sub.f}] {244} | 0.05           | 0.05           | 5     | 0           |
| [SAMPLE] binvcrhs_ [/{rwthfs/rz/cluster/work/hpclab17/NPB3.3-MZ-MPI/BT-MZ/solve_sub.f}] {332} | 0.05           | 0.05           | 5     | 0           |
| [SAMPLE] binvcrhs_ [/{rwthfs/rz/cluster/work/hpclab17/NPB3.3-MZ-MPI/BT-MZ/solve_sub.f}] {275} | 0.05           | 0.05           | 5     | 0           |
| [SAMPLE] binvcrhs_ [/{rwthfs/rz/cluster/work/hpclab17/NPB3.3-MZ-MPI/BT-MZ/solve_sub.f}] {331} | 0.04           | 0.04           | 4     | 0           |
| [SAMPLE] binvcrhs_ [/{rwthfs/rz/cluster/work/hpclab17/NPB3.3-MZ-MPI/BT-MZ/solve_sub.f}] {445} | 0.04           | 0.04           | 4     | 0           |
| [SAMPLE] binvcrhs_ [/{rwthfs/rz/cluster/work/hpclab17/NPB3.3-MZ-MPI/BT-MZ/solve_sub.f}] {254} | 0.04           | 0.04           | 4     | 0           |
| [SAMPLE] binvcrhs_ [/{rwthfs/rz/cluster/work/hpclab17/NPB3.3-MZ-MPI/BT-MZ/solve_sub.f}] {314} | 0.04           | 0.04           | 4     | 0           |
| [SAMPLE] binvcrhs_ [/{rwthfs/rz/cluster/work/hpclab17/NPB3.3-MZ-MPI/BT-MZ/solve_sub.f}] {343} | 0.04           | 0.04           | 4     | 0           |
| [SAMPLE] binvcrhs_ [/{rwthfs/rz/cluster/work/hpclab17/NPB3.3-MZ-MPI/BT-MZ/solve_sub.f}] {403} | 0.04           | 0.04           | 4     | 0           |
| [SAMPLE] binvcrhs_ [/{rwthfs/rz/cluster/work/hpclab17/NPB3.3-MZ-MPI/BT-MZ/solve_sub.f}] {389} | 0.03           | 0.03           | 3     | 0           |
| [SAMPLE] binvcrhs_ [/{rwthfs/rz/cluster/work/hpclab17/NPB3.3-MZ-MPI/BT-MZ/solve_sub.f}] {415} | 0.03           | 0.03           | 3     | 0           |
| [SAMPLE] binvcrhs_ [/{rwthfs/rz/cluster/work/hpclab17/NPB3.3-MZ-MPI/BT-MZ/solve_sub.f}] {247} | 0.03           | 0.03           | 3     | 0           |
| [SAMPLE] binvcrhs_ [/{rwthfs/rz/cluster/work/hpclab17/NPB3.3-MZ-MPI/BT-MZ/solve_sub.f}] {300} | 0.03           | 0.03           | 3     | 0           |
| [SAMPLE] binvcrhs_ [/{rwthfs/rz/cluster/work/hpclab17/NPB3.3-MZ-MPI/BT-MZ/solve_sub.f}] {309} | 0.03           | 0.03           | 3     | 0           |
| [SAMPLE] binvcrhs_ [/{rwthfs/rz/cluster/work/hpclab17/NPB3.3-MZ-MPI/BT-MZ/solve_sub.f}] {444} | 0.03           | 0.03           | 3     | 0           |
| [SAMPLE] binvcrhs_ [/{rwthfs/rz/cluster/work/hpclab17/NPB3.3-MZ-MPI/BT-MZ/solve_sub.f}] {468} | 0.03           | 0.03           | 3     | 0           |
| [SAMPLE] binvcrhs_ [/{rwthfs/rz/cluster/work/hpclab17/NPB3.3-MZ-MPI/BT-MZ/solve_sub.f}] {242} | 0.03           | 0.03           | 3     | 0           |
| [SAMPLE] binvcrhs_ [/{rwthfs/rz/cluster/work/hpclab17/NPB3.3-MZ-MPI/BT-MZ/solve_sub.f}] {407} | 0.03           | 0.03           | 3     | 0           |
| [SAMPLE] binvcrhs_ [/{rwthfs/rz/cluster/work/hpclab17/NPB3.3-MZ-MPI/BT-MZ/solve_sub.f}] {412} | 0.03           | 0.03           | 3     | 0           |

# TAU – Event Based Sampling (EBS)

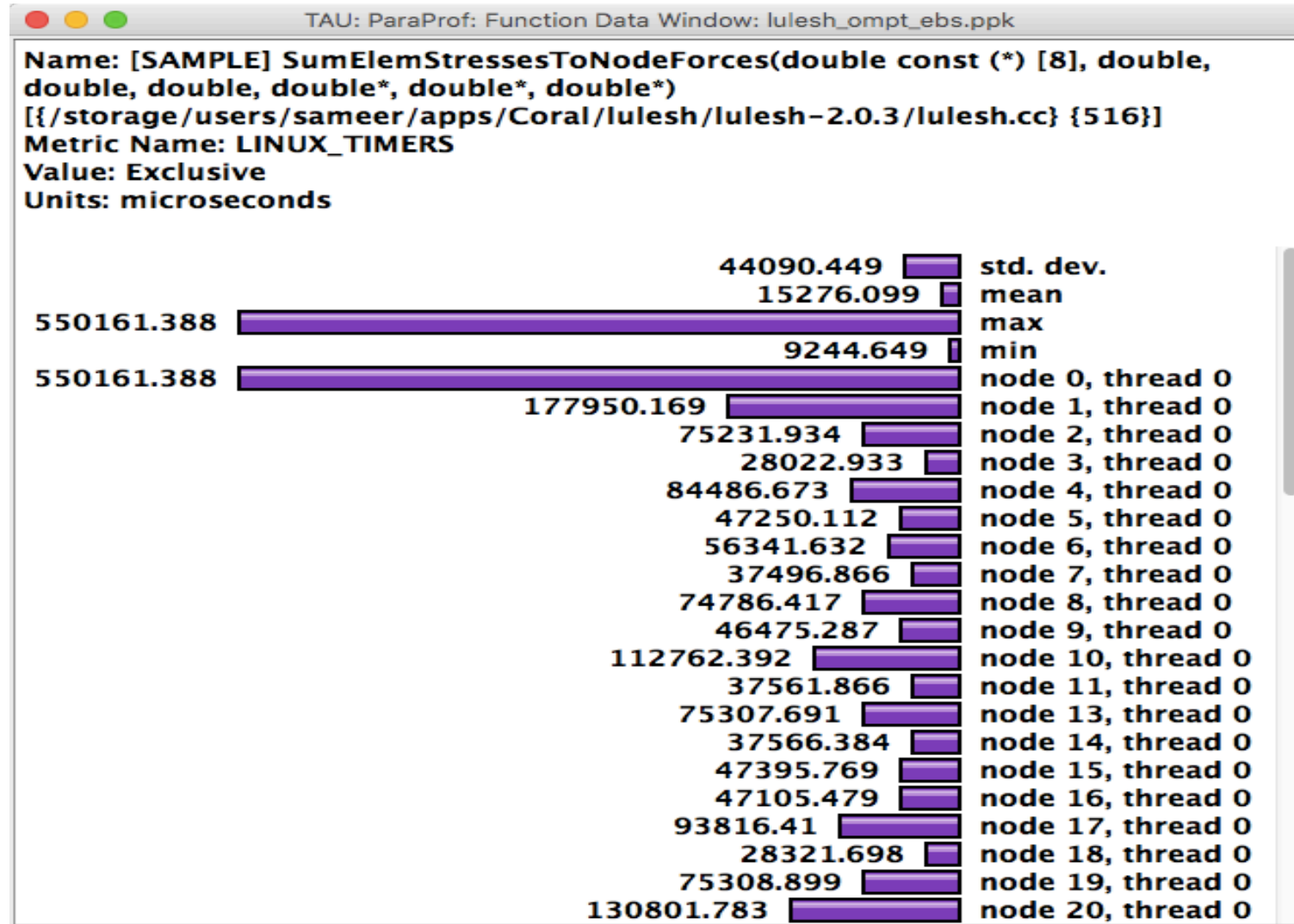

% export TAU\_SAMPLING=1

# Callstack Sampling in TAU

TAU: ParaProf: Statistics for: n,c,t 2,0,0 - gamess\_unw\_call\_ebs.ppk

| Name                                                                                                                                  | Inclusive TIME | Calls |
|---------------------------------------------------------------------------------------------------------------------------------------|----------------|-------|
| ▾ .TAU application                                                                                                                    | 79.592         | 1     |
| ▾ MPI_Recv()                                                                                                                          | 75.607         | 6,870 |
| ▾ [CONTEXT] MPI_Recv()                                                                                                                | 74.848         | 1,497 |
| ▸ [UNWIND] /gpfs/mira-home/sameer/gamess-theta-tau/object/unport.f.410 [ @ ] MAIN__ [ { /gpfs/mira-home/sameer/gamess-theta-t         | 26.196         | 524   |
| ▸ [UNWIND] /gpfs/mira-home/yuri/dist/Github/gamess-theta-tau/ddi/src/ddi_fortran.c.67 [ @ ] begin_ [ { /gpfs/mira-home/sameer/g       | 21.7           | 434   |
| ▸ [UNWIND] /gpfs/mira-home/sameer/gamess-theta-tau/object/gamess.f.538 [ @ ] main [ { /gpfs/mira-home/sameer/gamess-theta-ta          | 11.85          | 237   |
| ▸ [UNWIND] /gpfs/mira-home/yuri/dist/Github/gamess-theta-tau/ddi/src/ddi_init.c.113 [ @ ] ddi_init_ [ { /gpfs/mira-home/yuri/dist/Gi  | 8.701          | 174   |
| ▸ [UNWIND] /gpfs/mira-home/yuri/dist/Github/gamess-theta-tau/ddi/src/ddi_server.c.99 [ @ ] DDI_Init [ { /gpfs/mira-home/yuri/dist/C   | 5.75           | 115   |
| ▸ [UNWIND] /lib64/libc-2.22.so.0 [ @ ] _start [ { /home/abuild/rpmbuild/BUILD/glibc-2.22/csu/./sysdeps/x86_64/start.S } {118} ]       | 0.2            | 4     |
| ▸ [SAMPLE] GNII_DlaProgress [ { /opt/cray/ugni/6.0.14-6.0.4.0_14.1__ge7db4a2.ari/lib64/libugni.so.0.6.0 } {0} ]                       | 0.2            | 4     |
| ▸ [UNWIND] [ /opt/cray/ugni/6.0.14-6.0.4.0_14.1__ge7db4a2.ari/lib64/libugni.so.0.6.0.0 ] [ @ ] UNRESOLVED UNKNOWN                     | 0.15           | 3     |
| ▸ [SAMPLE] GNI_CqGetEvent [ { /opt/cray/ugni/6.0.14-6.0.4.0_14.1__ge7db4a2.ari/lib64/libugni.so.0.6.0 } {0} ]                         | 0.051          | 1     |
| ▸ [UNWIND] /opt/cray/pe/mpt/7.6.3/gni/mpich-intel/16.0/lib/libmpich_intel.so.3.0.1.0 [ @ ] MPIDI_CH3I_Progress [ { /opt/cray/pe/mpt/7 | 0.05           | 1     |
| ▸ MPI_Finalize()                                                                                                                      | 3.601          | 1     |
| ▸ MPI_Send()                                                                                                                          | 0.122          | 6,866 |
| ▸ MPI_Init_thread()                                                                                                                   | 0.112          | 1     |
| ▸ [CONTEXT] .TAU application                                                                                                          | 0.05           | 1     |
| ▸ MPI_Bcast()                                                                                                                         | 0.014          | 6     |
| ▸ MPI_Allgather()                                                                                                                     | 0.004          | 3     |
| ▸ MPI_Barrier()                                                                                                                       | 0.003          | 7     |
| ▸ MPI_Comm_create()                                                                                                                   | 0.002          | 4     |
| ▸ MPI_Gather()                                                                                                                        | 0.002          | 1     |
| ▸ MPI_Comm_split()                                                                                                                    | 0.002          | 1     |
| ▸ MPI_Group_intersection()                                                                                                            | 0.001          | 1     |
| ▸ MPI_Comm_group()                                                                                                                    | 0.001          | 1     |
| ▸ MPI_Group_incl()                                                                                                                    | 0              | 3     |
| ▸ MPI_Comm_rank()                                                                                                                     | 0              | 6     |
| ▸ MPI_Comm_size()                                                                                                                     | 0              | 2     |

% export TAU\_SAMPLING=1; export TAU\_EBS\_UNWIND=1



# UNWINDING CALLSTACKS

TAU: ParaProf: Statistics for: n,c,t 2,0,0 - gamess\_unw\_call\_ebs.ppk

| Name                                                                                                                                                                                     | Inclusive TIME | Calls |
|------------------------------------------------------------------------------------------------------------------------------------------------------------------------------------------|----------------|-------|
| └─ .TAU application                                                                                                                                                                      | 79.592         | 1     |
| └─ └─ MPI_Recv()                                                                                                                                                                         | 75.607         | 6,870 |
| └─ └─ └─ [CONTEXT] MPI_Recv()                                                                                                                                                            | 74.848         | 1,497 |
| └─ └─ └─ └─ [UNWIND] /gpfs/mira-home/sameer/gamess-theta-tau/object/unport.f.410 [ @ ] MAIN__ [ { /gpfs/mira-home/sameer/gamess-theta-                                                   | 26.196         | 524   |
| └─ └─ └─ └─ [UNWIND] /gpfs/mira-home/yuri/dist/Github/gamess-theta-tau/ddi/src/ddi_fortran.c.67 [ @ ] begin_ [ { /gpfs/mira-home/sameer/g                                                | 21.7           | 434   |
| └─ └─ └─ └─ └─ [UNWIND] /gpfs/mira-home/yuri/dist/Github/gamess-theta-tau/ddi/src/ddi_init.c.113 [ @ ] ddi_init_ [ { /gpfs/mira-home/yuri/dist                                           | 21.7           | 434   |
| └─ └─ └─ └─ └─ └─ [UNWIND] /gpfs/mira-home/yuri/dist/Github/gamess-theta-tau/ddi/src/ddi_server.c.99 [ @ ] DDI_Init [ { /gpfs/mira-home/yuri/                                            | 21.7           | 434   |
| └─ └─ └─ └─ └─ └─ └─ [UNWIND] /gpfs/mira-home/yuri/dist/Github/gamess-theta-tau/ddi/src/ddi_recv.c.65 [ @ ] DDI_Server [ { /gpfs/mira-home/y                                             | 21.7           | 434   |
| └─ └─ └─ └─ └─ └─ └─ └─ [UNWIND] /lus/theta-fs0/software/perftools/tau/tau-2.26.3/src/Profile/TauMpi.c.2371 [ @ ] DDI_Recv_request [ { /gpfs/mira                                        | 21.7           | 434   |
| └─ └─ └─ └─ └─ └─ └─ └─ └─ [UNWIND] /opt/cray/pe/mpt/7.6.3/gni/mpich-intel/16.0/lib/libmpich_intel.so.3.0.1.0 [ @ ] MPI_Recv [ { /lus/theta-fs0/sof                                      | 21.7           | 434   |
| └─ └─ └─ └─ └─ └─ └─ └─ └─ └─ [UNWIND] /opt/cray/pe/mpt/7.6.3/gni/mpich-intel/16.0/lib/libmpich_intel.so.3.0.1.0 [ @ ] PMPI_Recv [ { /opt/cray/pe/n                                      | 21.7           | 434   |
| └─ └─ └─ └─ └─ └─ └─ └─ └─ └─ └─ [UNWIND] /opt/cray/pe/mpt/7.6.3/gni/mpich-intel/16.0/lib/libmpich_intel.so.3.0.1.0 [ @ ] MPIDI_CH3I_Progress [ { /c                                     | 21.45          | 429   |
| └─ └─ └─ └─ └─ └─ └─ └─ └─ └─ └─ └─ [UNWIND] /opt/cray/ugni/6.0.14-6.0.4.0_14.1__ge7db4a2.ari/lib64/libugni.so.0.6.0.0 [ @ ] MPID_nem_gni_poll [ { /                                     | 15.95          | 319   |
| └─ └─ └─ └─ └─ └─ └─ └─ └─ └─ └─ └─ └─ [SAMPLE] GNI_SmsgGetNextWTag [ { /opt/cray/ugni/6.0.14-6.0.4.0_14.1__ge7db4a2.ari/lib64/libugni.so.0.6.0 }                                        | 10.349         | 207   |
| └─ └─ └─ └─ └─ └─ └─ └─ └─ └─ └─ └─ └─ [SAMPLE] GNI_CqGetEvent [ { /opt/cray/ugni/6.0.14-6.0.4.0_14.1__ge7db4a2.ari/lib64/libugni.so.0.6.0 } {0}                                         | 5.6            | 112   |
| └─ └─ └─ └─ └─ └─ └─ └─ └─ └─ └─ └─ └─ └─ [UNWIND] gni_poll.c.0 [ @ ] MPID_nem_gni_poll [ { /opt/cray/pe/mpt/7.6.3/gni/mpich-intel/16.0/lib/libmpich_inte                                | 5.25           | 105   |
| └─ └─ └─ └─ └─ └─ └─ └─ └─ └─ └─ └─ └─ └─ └─ [UNWIND] /opt/cray/pe/mpt/7.6.3/gni/mpich-intel/16.0/lib/libmpich_intel.so.3.0.1.0 [ @ ] MPID_nem_gni_poll [ { /                            | 0.25           | 5     |
| └─ └─ └─ └─ └─ └─ └─ └─ └─ └─ └─ └─ └─ └─ └─ └─ [UNWIND] UNRESOLVED [ @ ] MPIDI_CH3I_Progress [ { /opt/cray/pe/mpt/7.6.3/gni/mpich-intel/16.0/lib/libmpich_int                           | 0.25           | 5     |
| └─ └─ └─ └─ └─ └─ └─ └─ └─ └─ └─ └─ └─ └─ └─ └─ └─ [UNWIND] /gpfs/mira-home/sameer/gamess-theta-tau/object/gamess.f.538 [ @ ] main [ { /gpfs/mira-home/sameer/gamess-theta-ta            | 11.85          | 237   |
| └─ └─ └─ └─ └─ └─ └─ └─ └─ └─ └─ └─ └─ └─ └─ └─ └─ [UNWIND] /gpfs/mira-home/yuri/dist/Github/gamess-theta-tau/ddi/src/ddi_init.c.113 [ @ ] ddi_init_ [ { /gpfs/mira-home/yuri/dist/G     | 8.701          | 174   |
| └─ └─ └─ └─ └─ └─ └─ └─ └─ └─ └─ └─ └─ └─ └─ └─ └─ [UNWIND] /gpfs/mira-home/yuri/dist/Github/gamess-theta-tau/ddi/src/ddi_server.c.99 [ @ ] DDI_Init [ { /gpfs/mira-home/yuri/dist/      | 5.75           | 115   |
| └─ └─ └─ └─ └─ └─ └─ └─ └─ └─ └─ └─ └─ └─ └─ └─ └─ └─ [UNWIND] /lib64/libc-2.22.so.0 [ @ ] _start [ { /home/abuild/rpmbuild/BUILD/glibc-2.22/csu/./sysdeps/x86_64/start.S } {118}        | 0.2            | 4     |
| └─ └─ └─ └─ └─ └─ └─ └─ └─ └─ └─ └─ └─ └─ └─ └─ └─ └─ [SAMPLE] GNII_DlaProgress [ { /opt/cray/ugni/6.0.14-6.0.4.0_14.1__ge7db4a2.ari/lib64/libugni.so.0.6.0 } {0}                        | 0.2            | 4     |
| └─ └─ └─ └─ └─ └─ └─ └─ └─ └─ └─ └─ └─ └─ └─ └─ └─ └─ [UNWIND] [ /opt/cray/ugni/6.0.14-6.0.4.0_14.1__ge7db4a2.ari/lib64/libugni.so.0.6.0.0 ] [ @ ] UNRESOLVED UNKNOWN                    | 0.15           | 3     |
| └─ └─ └─ └─ └─ └─ └─ └─ └─ └─ └─ └─ └─ └─ └─ └─ └─ └─ [SAMPLE] GNI_CqGetEvent [ { /opt/cray/ugni/6.0.14-6.0.4.0_14.1__ge7db4a2.ari/lib64/libugni.so.0.6.0 } {0}                          | 0.051          | 1     |
| └─ └─ └─ └─ └─ └─ └─ └─ └─ └─ └─ └─ └─ └─ └─ └─ └─ └─ [UNWIND] /opt/cray/pe/mpt/7.6.3/gni/mpich-intel/16.0/lib/libmpich_intel.so.3.0.1.0 [ @ ] MPIDI_CH3I_Progress [ { /opt/cray/pe/mpt/ | 0.05           | 1     |
| └─ └─ └─ └─ └─ └─ └─ └─ └─ └─ └─ └─ └─ └─ └─ └─ └─ └─ MPI_Finalize()                                                                                                                     | 3.601          | 1     |
| └─ └─ └─ └─ └─ └─ └─ └─ └─ └─ └─ └─ └─ └─ └─ └─ └─ └─ └─ MPI_Send()                                                                                                                      | 0.122          | 6,866 |
| └─ └─ └─ └─ └─ └─ └─ └─ └─ └─ └─ └─ └─ └─ └─ └─ └─ └─ └─ MPI_Init_thread()                                                                                                               | 0.112          | 1     |
| └─ └─ └─ └─ └─ └─ └─ └─ └─ └─ └─ └─ └─ └─ └─ └─ └─ └─ └─ [CONTEXT] .TAU application                                                                                                      | 0.05           | 1     |

% export TAU\_SAMPLING=1; export TAU\_EBS\_UNWIND=1

# UNWINDING CALLSTACKS

TAU: ParaProf: Statistics for: n,c,t 2,0,0 - gamess\_unw\_call\_ebs.ppk

| Name                                                                                                                             | Inclusive TIME | Calls |
|----------------------------------------------------------------------------------------------------------------------------------|----------------|-------|
| ▼ .TAU application                                                                                                               | 79.592         | 1     |
| ▼ MPI_Recv()                                                                                                                     | 75.607         | 6,870 |
| ▼ [CONTEXT] MPI_Recv()                                                                                                           | 74.848         | 1,497 |
| ▶ [UNWIND] /gpfs/mira-home/sameer/gamess-theta-tau/object/unport.f.410 [@] MAIN_ [{}gpfs/mira-home/sameer/gamess-theta-          | 26.196         | 524   |
| ▶ [UNWIND] /gpfs/mira-home/yuri/dist/Github/gamess-theta-tau/ddi/src/ddi_fortran.c.67 [@] beging_ [{}gpfs/mira-home/sameer/g     | 21.7           | 434   |
| ▼ [UNWIND] /gpfs/mira-home/sameer/gamess-theta-tau/object/gamess.f.538 [@] main [{}gpfs/mira-home/sameer/gamess-theta-ta         | 11.85          | 237   |
| ▼ [UNWIND] /gpfs/mira-home/sameer/gamess-theta-tau/object/unport.f.410 [@] MAIN_ [{}gpfs/mira-home/sameer/gamess-thet            | 11.85          | 237   |
| ▼ [UNWIND] /gpfs/mira-home/yuri/dist/Github/gamess-theta-tau/ddi/src/ddi_fortran.c.67 [@] beging_ [{}gpfs/mira-home/sam          | 11.85          | 237   |
| ▼ [UNWIND] /gpfs/mira-home/yuri/dist/Github/gamess-theta-tau/ddi/src/ddi_init.c.113 [@] ddi_init_ [{}gpfs/mira-home/yur          | 11.85          | 237   |
| ▼ [UNWIND] /gpfs/mira-home/yuri/dist/Github/gamess-theta-tau/ddi/src/ddi_server.c.99 [@] DDI_Init [{}gpfs/mira-home/             | 11.85          | 237   |
| ▼ [UNWIND] /gpfs/mira-home/yuri/dist/Github/gamess-theta-tau/ddi/src/ddi_recv.c.65 [@] DDI_Server [{}gpfs/mira-ho                | 11.85          | 237   |
| ▼ [UNWIND] /lus/theta-fs0/software/perftools/tau/tau-2.26.3/src/Profile/TauMpi.c.2371 [@] DDI_Recv_request [{}gpfs               | 11.85          | 237   |
| ▼ [UNWIND] /opt/cray/pe/mpt/7.6.3/gni/mpich-intel/16.0/lib/libmpich_intel.so.3.0.1.0 [@] MPI_Recv [{}lus/theta-fs0               | 11.85          | 237   |
| ▼ [UNWIND] /opt/cray/pe/mpt/7.6.3/gni/mpich-intel/16.0/lib/libmpich_intel.so.3.0.1.0 [@] PMPI_Recv [{}opt/cray,                  | 11.7           | 234   |
| ▶ [SAMPLE] MPIDI_CH3I_Progress [{}opt/cray/pe/mpt/7.6.3/gni/mpich-intel/16.0/lib/libmpich_intel.so.3.0.1} {0                     | 11.3           | 226   |
| ▶ [SAMPLE] MPIDU_Sched_are_pending [{}opt/cray/pe/mpt/7.6.3/gni/mpich-intel/16.0/lib/libmpich_intel.so.3.0                       | 0.2            | 4     |
| ▶ [SAMPLE] MPID_nem_gni_poll [{}opt/cray/pe/mpt/7.6.3/gni/mpich-intel/16.0/lib/libmpich_intel.so.3.0.1} {0}                      | 0.15           | 3     |
| ▶ [SAMPLE] MPID_nem_network_poll [{}opt/cray/pe/mpt/7.6.3/gni/mpich-intel/16.0/lib/libmpich_intel.so.3.0.1                       | 0.05           | 1     |
| ▶ [UNWIND] ch3_progress.c.0 [@] PMPI_Recv [{}opt/cray/pe/mpt/7.6.3/gni/mpich-intel/16.0/lib/libmpich_intel.so.                   | 0.15           | 3     |
| ▶ [UNWIND] /gpfs/mira-home/yuri/dist/Github/gamess-theta-tau/ddi/src/ddi_init.c.113 [@] ddi_init_ [{}gpfs/mira-home/yuri/dist/G  | 8.701          | 174   |
| ▶ [UNWIND] /gpfs/mira-home/yuri/dist/Github/gamess-theta-tau/ddi/src/ddi_server.c.99 [@] DDI_Init [{}gpfs/mira-home/yuri/dist/   | 5.75           | 115   |
| ▶ [UNWIND] /lib64/libc-2.22.so.0 [@] _start [{}home/abuild/rpmbuild/BUILD/glibc-2.22/csu/./sysdeps/x86_64/start.S} {118}         | 0.2            | 4     |
| ▶ [SAMPLE] GNII_DlaProgress [{}opt/cray/ugni/6.0.14-6.0.4.0_14.1__ge7db4a2.ari/lib64/libugni.so.0.6.0} {0}                       | 0.2            | 4     |
| ▶ [UNWIND] [/opt/cray/ugni/6.0.14-6.0.4.0_14.1__ge7db4a2.ari/lib64/libugni.so.0.6.0.0] [@] UNRESOLVED UNKNOWN                    | 0.15           | 3     |
| ▶ [SAMPLE] GNI_CqGetEvent [{}opt/cray/ugni/6.0.14-6.0.4.0_14.1__ge7db4a2.ari/lib64/libugni.so.0.6.0} {0}                         | 0.051          | 1     |
| ▶ [UNWIND] /opt/cray/pe/mpt/7.6.3/gni/mpich-intel/16.0/lib/libmpich_intel.so.3.0.1.0 [@] MPIDI_CH3I_Progress [{}opt/cray/pe/mpt/ | 0.05           | 1     |
| ▶ MPI_Finalize()                                                                                                                 | 3.601          | 1     |
| ▶ MPI_Send()                                                                                                                     | 0.122          | 6,866 |
| ▶ MPI_Init_thread()                                                                                                              | 0.112          | 1     |
| ▶ [CONTEXT] .TAU application                                                                                                     | 0.05           | 1     |

# Callsite Profiling and Tracing

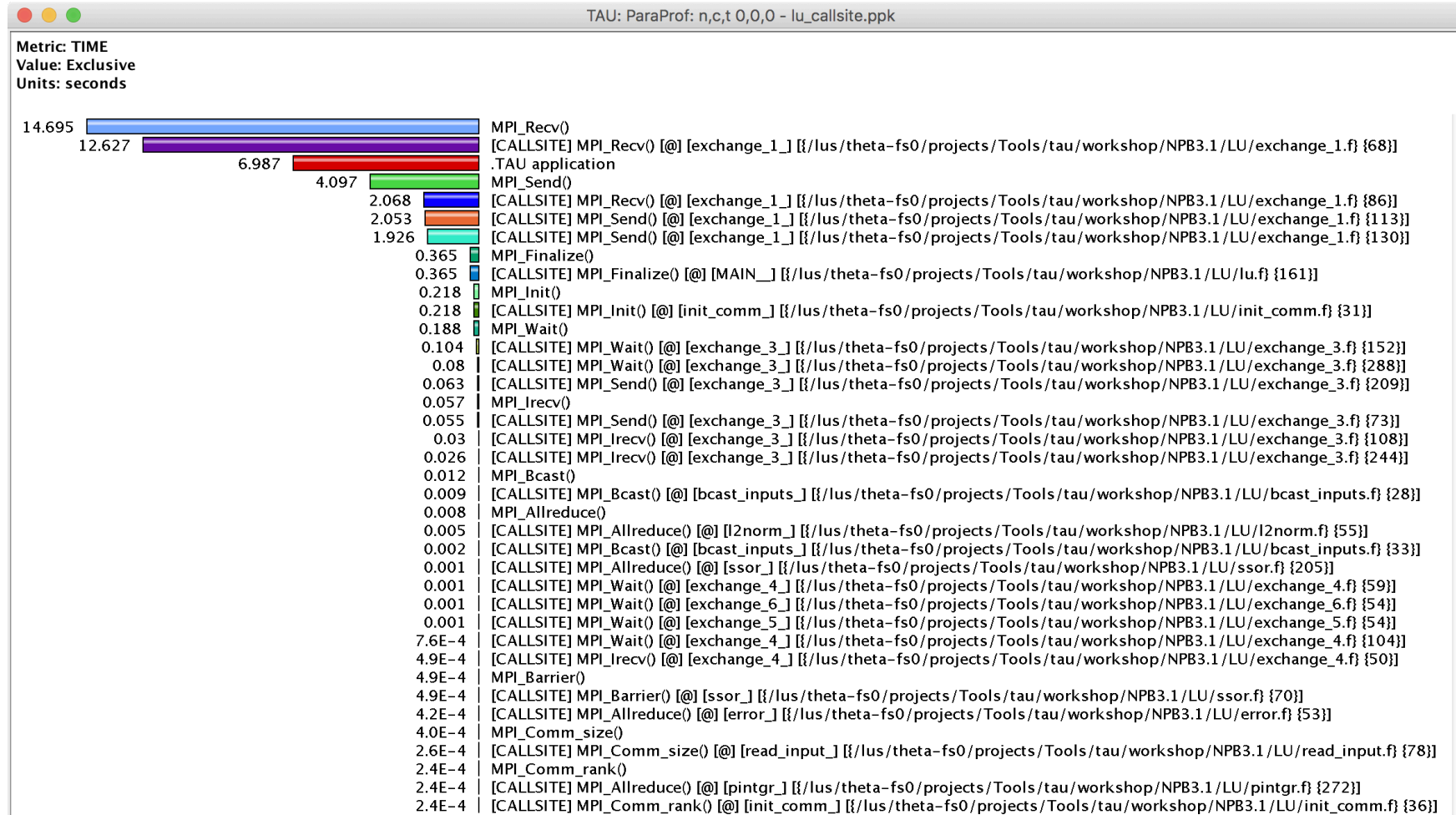

% export TAU\_CALLSITE=1



# CALLPATH THREAD RELATIONS WINDOW

TAU: ParaProf: Call Path Data n,c,t, 2,0,0 - gamess\_unw\_call\_ebs.ppk

Metric Name: TIME  
Sorted By: Inclusive  
Units: seconds

|     | Exclusive | Inclusive | Calls/Tot.Calls | Name[id]                                                                                       |
|-----|-----------|-----------|-----------------|------------------------------------------------------------------------------------------------|
| --> | 0.121     | 79.592    | 1               | .TAU application                                                                               |
|     | 0.002     | 0.002     | 1/1             | MPI_Gather()                                                                                   |
|     | 0.004     | 0.004     | 3/3             | MPI_Allgather()                                                                                |
|     | 0.122     | 0.122     | 6866/6866       | MPI_Send()                                                                                     |
|     | 0.002     | 0.002     | 1/1             | MPI_Comm_split()                                                                               |
|     | 8.9E-5    | 8.9E-5    | 2/2             | MPI_Comm_size()                                                                                |
|     | 4.6E-4    | 4.6E-4    | 3/3             | MPI_Group_incl()                                                                               |
|     | 75.607    | 75.607    | 6870/6870       | MPI_Recv()                                                                                     |
|     | 0.002     | 0.002     | 4/4             | MPI_Comm_create()                                                                              |
|     | 9.5E-5    | 9.5E-5    | 6/6             | MPI_Comm_rank()                                                                                |
|     | 5.4E-4    | 5.4E-4    | 1/1             | MPI_Comm_group()                                                                               |
|     | 0.003     | 0.003     | 7/7             | MPI_Barrier()                                                                                  |
|     | 0.112     | 0.112     | 1/1             | MPI_Init_thread()                                                                              |
|     | 6.3E-4    | 6.3E-4    | 1/1             | MPI_Group_intersection()                                                                       |
|     | 0         | 0.05      | 1/1             | [CONTEXT] .TAU application                                                                     |
|     | 3.601     | 3.601     | 1/1             | MPI_Finalize()                                                                                 |
|     | 0.014     | 0.014     | 6/6             | MPI_Bcast()                                                                                    |
| --> | 75.607    | 75.607    | 6870/6870       | .TAU application                                                                               |
|     | 75.607    | 75.607    | 6870            | MPI_Recv()                                                                                     |
|     | 0         | 74.848    | 1497/1497       | [CONTEXT] MPI_Recv()                                                                           |
| --> | 0         | 74.848    | 1497/1497       | MPI_Recv()                                                                                     |
|     | 0         | 74.848    | 1497            | [CONTEXT] MPI_Recv()                                                                           |
|     | 0         | 8.701     | 174/1371        | [UNWIND] /gpfs/mira-home/yuri/dist/Github/gamess-theta-tau/ddi/src/ddi_init.c.113 [0] ddi_in   |
|     | 0         | 26.196    | 524/763         | [UNWIND] /gpfs/mira-home/sameer/gamess-theta-tau/object/unport.f.410 [0] MAIN_ [0] /gpfs/mira  |
|     | 0.2       | 0.2       | 4/138           | [SAMPLE] GNII_DlaProgress [0] /opt/cray/ugni/6.0.14-6.0.4.0_14.1_ge7db4a2.ari/lib64/libugni.so |
|     | 0         | 5.75      | 115/1484        | [UNWIND] /gpfs/mira-home/yuri/dist/Github/gamess-theta-tau/ddi/src/ddi_server.c.99 [0] DDI_    |
|     | 0         | 0.2       | 4/5             | [UNWIND] /lib64/libc-2.22.so.0 [0] _start [0] /home/abuild/rpmbuild/BUILD/glibc-2.22/csu/./s   |
|     | 0         | 11.85     | 237/239         | [UNWIND] /gpfs/mira-home/sameer/gamess-theta-tau/object/gamess.f.538 [0] main [0] /gpfs/mira-l |
|     | 0.051     | 0.051     | 1/273           | [SAMPLE] GNI_CqGetEvent [0] /opt/cray/ugni/6.0.14-6.0.4.0_14.1_ge7db4a2.ari/lib64/libugni.so   |
|     | 0         | 0.05      | 1/1197          | [UNWIND] /opt/cray/pe/mpt/7.6.3/gni/mpich-intel/16.0/lib/libmpich_intel.so.3.0.1.0 [0] MPID:   |
|     | 0         | 0.15      | 3/7             | [UNWIND] [/opt/cray/ugni/6.0.14-6.0.4.0_14.1_ge7db4a2.ari/lib64/libugni.so.0.6.0.0] [0] UNI    |
|     | 0         | 21.7      | 434/1197        | [UNWIND] /gpfs/mira-home/yuri/dist/Github/gamess-theta-tau/ddi/src/ddi_fortran.c.67 [0] beg:   |

# CALLPATH THREAD RELATIONS WINDOW

TAU: ParaProf: Call Path Data n,c,t, 2,0,0 - gamess\_unw\_call\_ebs.ppk

Metric Name: TIME  
Sorted By: Exclusive  
Units: seconds

|     | Exclusive | Inclusive | Calls/Tot.Calls | Name[id]                                                                                          |
|-----|-----------|-----------|-----------------|---------------------------------------------------------------------------------------------------|
| --> | 75.607    | 75.607    | 6870/6870       | .TAU application                                                                                  |
|     | 75.607    | 75.607    | 6870            | MPI_Recv()                                                                                        |
|     | 0         | 74.848    | 1497/1497       | [CONTEXT] MPI_Recv()                                                                              |
|     | 0.15      | 0.15      | 3/444           | [UNWIND] /opt/cray/pe/mpt/7.6.3/gni/mpich-intel/16.0/lib/libmpich_intel.so.3.0.1.0 [@] PMPI_Recv  |
|     | 22.046    | 22.046    | 441/444         | [UNWIND] /opt/cray/pe/mpt/7.6.3/gni/mpich-intel/16.0/lib/libmpich_intel.so.3.0.1.0 [@] MPIDI_CH3I |
| --> | 22.196    | 22.196    | 444             | [SAMPLE] MPID_nem_gni_poll [{/opt/cray/pe/mpt/7.6.3/gni/mpich-intel/16.0/lib/libmpich_intel.so.3  |
|     | 5.6       | 5.6       | 112/273         | [UNWIND] /opt/cray/ugni/6.0.14-6.0.4.0_14.1__ge7db4a2.ari/lib64/libugni.so.0.6.0.0 [@] MPID_nem_g |
|     | 0.051     | 0.051     | 1/273           | [CONTEXT] MPI_Recv()                                                                              |
|     | 7.651     | 7.651     | 153/273         | [UNWIND] /opt/cray/ugni/6.0.14-6.0.4.0_14.1__ge7db4a2.ari/lib64/libugni.so.0.6.0.0 [@] MPID_nem_g |
|     | 0.35      | 0.35      | 7/273           | [UNWIND] [/opt/cray/ugni/6.0.14-6.0.4.0_14.1__ge7db4a2.ari/lib64/libugni.so.0.6.0.0] [@] UNRESOLV |
| --> | 13.652    | 13.652    | 273             | [SAMPLE] GNI_CqGetEvent [{/opt/cray/ugni/6.0.14-6.0.4.0_14.1__ge7db4a2.ari/lib64/libugni.so.0.6.0 |
|     | 11.3      | 11.3      | 226/226         | [UNWIND] /opt/cray/pe/mpt/7.6.3/gni/mpich-intel/16.0/lib/libmpich_intel.so.3.0.1.0 [@] PMPI_Recv  |
| --> | 11.3      | 11.3      | 226             | [SAMPLE] MPIDI_CH3I_Progress [{/opt/cray/pe/mpt/7.6.3/gni/mpich-intel/16.0/lib/libmpich_intel.so  |
|     | 10.349    | 10.349    | 207/207         | [UNWIND] /opt/cray/ugni/6.0.14-6.0.4.0_14.1__ge7db4a2.ari/lib64/libugni.so.0.6.0.0 [@] MPID_nem_g |
| --> | 10.349    | 10.349    | 207             | [SAMPLE] GNI_MsgGetNextWTag [{/opt/cray/ugni/6.0.14-6.0.4.0_14.1__ge7db4a2.ari/lib64/libugni.so   |
|     | 0.2       | 0.2       | 4/138           | [CONTEXT] MPI_Recv()                                                                              |
|     | 6.701     | 6.701     | 134/138         | [UNWIND] /opt/cray/ugni/6.0.14-6.0.4.0_14.1__ge7db4a2.ari/lib64/libugni.so.0.6.0.0 [@] GNI_CqGetE |
| --> | 6.901     | 6.901     | 138             | [SAMPLE] GNII_DlaProgress [{/opt/cray/ugni/6.0.14-6.0.4.0_14.1__ge7db4a2.ari/lib64/libugni.so.0.6 |
|     | 5.25      | 5.25      | 105/109         | [UNWIND] gni_poll.c.0 [@] MPID_nem_gni_poll [{/opt/cray/pe/mpt/7.6.3/gni/mpich-intel/16.0/lib/li  |
|     | 0.2       | 0.2       | 4/109           | [UNWIND] gni_poll.c.0 [@] MPIDI_CH3I_Progress [{/opt/cray/pe/mpt/7.6.3/gni/mpich-intel/16.0/lib/  |
| --> | 5.45      | 5.45      | 109             | [SAMPLE] MPID_nem_gni_check_localCQ [{gni_poll.c} {0}]                                            |
|     | 3.601     | 3.601     | 1/1             | .TAU application                                                                                  |
| --> | 3.601     | 3.601     | 1               | MPI_Finalize()                                                                                    |

# Callsite Profiling and Tracing (TAU\_CALLSITE=1)

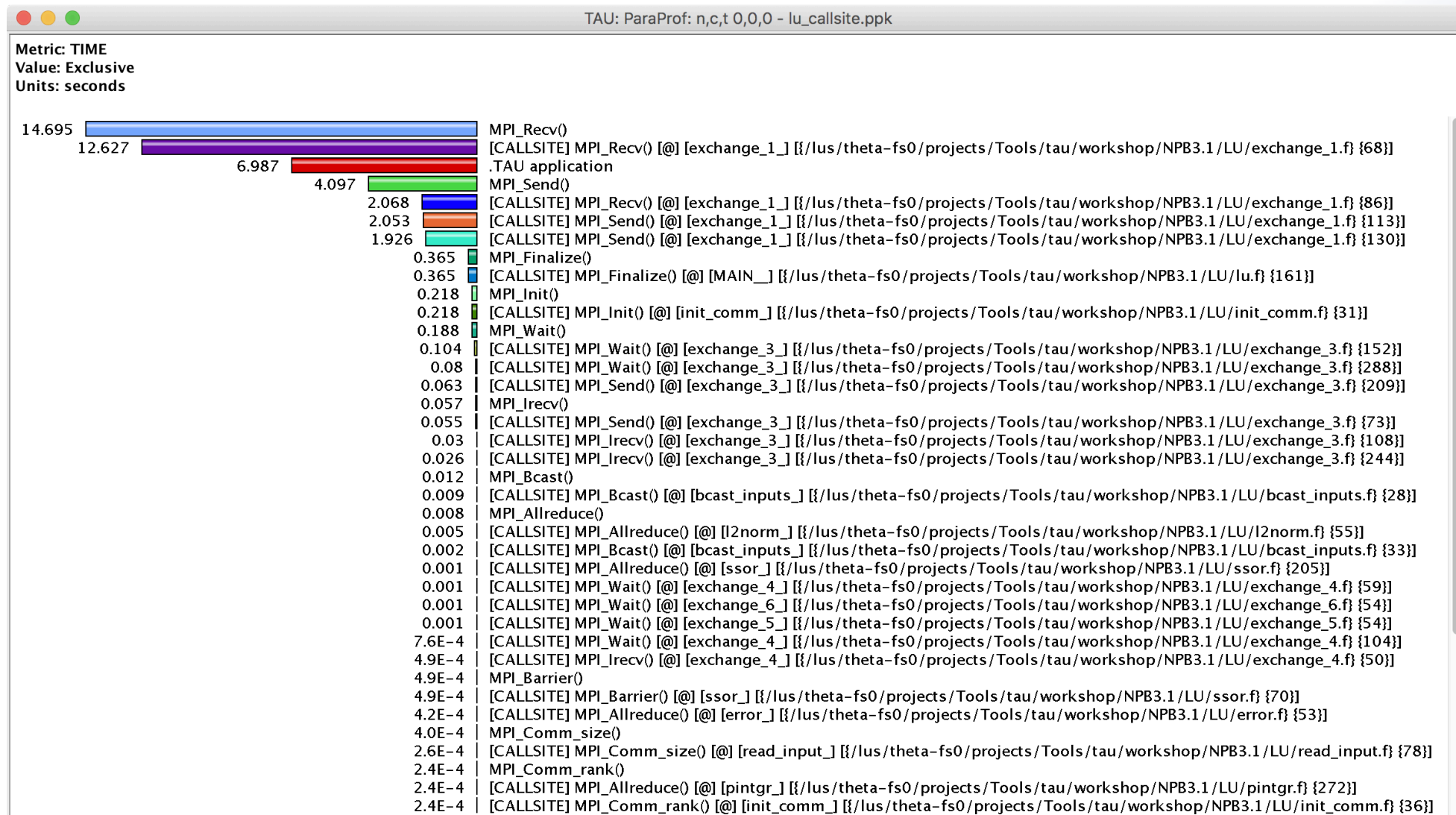

# TAU – Context Events

TAU: ParaProf: Context Events for thread: n,c,t, 1,0,0 – samarc\_obe\_4p\_iomem\_cp.ppk

| Name                                                                        | Total     | MeanValue  | NumSamples | MinValue | MaxValue  | Std. Dev.   |
|-----------------------------------------------------------------------------|-----------|------------|------------|----------|-----------|-------------|
| ▼ .TAU application                                                          |           |            |            |          |           |             |
| ▶ read()                                                                    |           |            |            |          |           |             |
| ▶ fopen64()                                                                 |           |            |            |          |           |             |
| ▶ fclose()                                                                  |           |            |            |          |           |             |
| ▼ OurMain()                                                                 |           |            |            |          |           |             |
| malloc size                                                                 | 25,235    | 1,097.174  | 23         | 11       | 12,032    | 2,851.143   |
| free size                                                                   | 22,707    | 1,746.692  | 13         | 11       | 12,032    | 3,660.642   |
| ▼ OurMain [{{wrapper.py}}{3}]                                               |           |            |            |          |           |             |
| ▶ read()                                                                    |           |            |            |          |           |             |
| malloc size                                                                 | 3,877     | 323.083    | 12         | 32       | 981       | 252.72      |
| free size                                                                   | 1,536     | 219.429    | 7          | 32       | 464       | 148.122     |
| ▶ fopen64()                                                                 |           |            |            |          |           |             |
| ▶ fclose()                                                                  |           |            |            |          |           |             |
| ▼ <module> [{{obe.py}}{8}]                                                  |           |            |            |          |           |             |
| ▼ writeRestartData [{{samarcInterface.py}}{145}]                            |           |            |            |          |           |             |
| ▼ samarcWriteRestartData                                                    |           |            |            |          |           |             |
| ▼ write()                                                                   |           |            |            |          |           |             |
| WRITE Bandwidth (MB/s) <file="samarc/restore.00002/nodes.00004/proc.00001"> |           | 74.565     | 117        | 0        | 2,156.889 | 246.386     |
| WRITE Bandwidth (MB/s) <file="samarc/restore.00001/nodes.00004/proc.00001"> |           | 77.594     | 117        | 0        | 1,941.2   | 228.366     |
| WRITE Bandwidth (MB/s)                                                      |           | 76.08      | 234        | 0        | 2,156.889 | 237.551     |
| Bytes Written <file="samarc/restore.00002/nodes.00004/proc.00001">          | 2,097,552 | 17,927.795 | 117        | 1        | 1,048,576 | 133,362.946 |
| Bytes Written <file="samarc/restore.00001/nodes.00004/proc.00001">          | 2,097,552 | 17,927.795 | 117        | 1        | 1,048,576 | 133,362.946 |
| Bytes Written                                                               | 4,195,104 | 17,927.795 | 234        | 1        | 1,048,576 | 133,362.946 |
| ▶ open64()                                                                  |           |            |            |          |           |             |

Write bandwidth per file

Bytes written to each file



# Callsite Profiling and Tracing

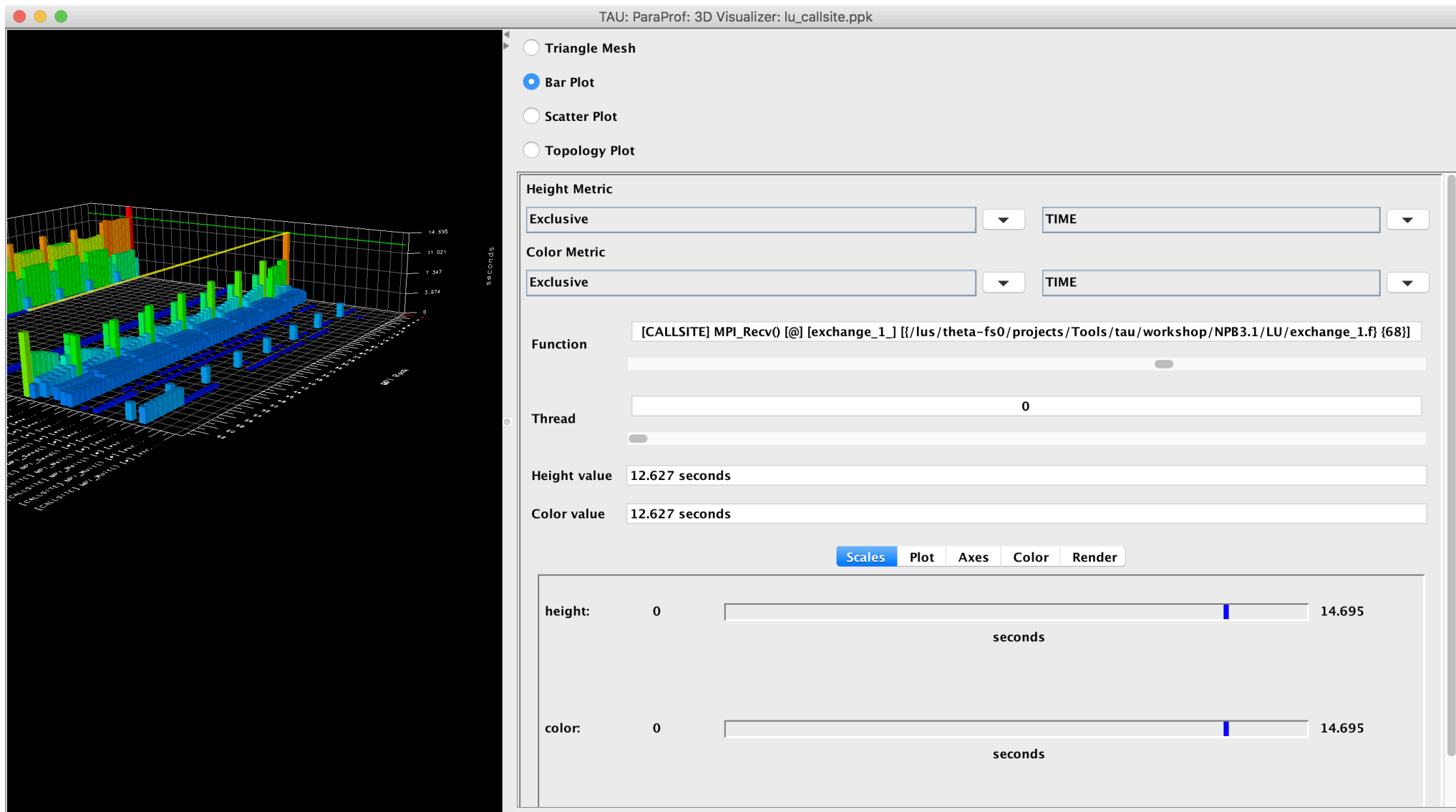



# ParaProf with Optimized Instrumentation

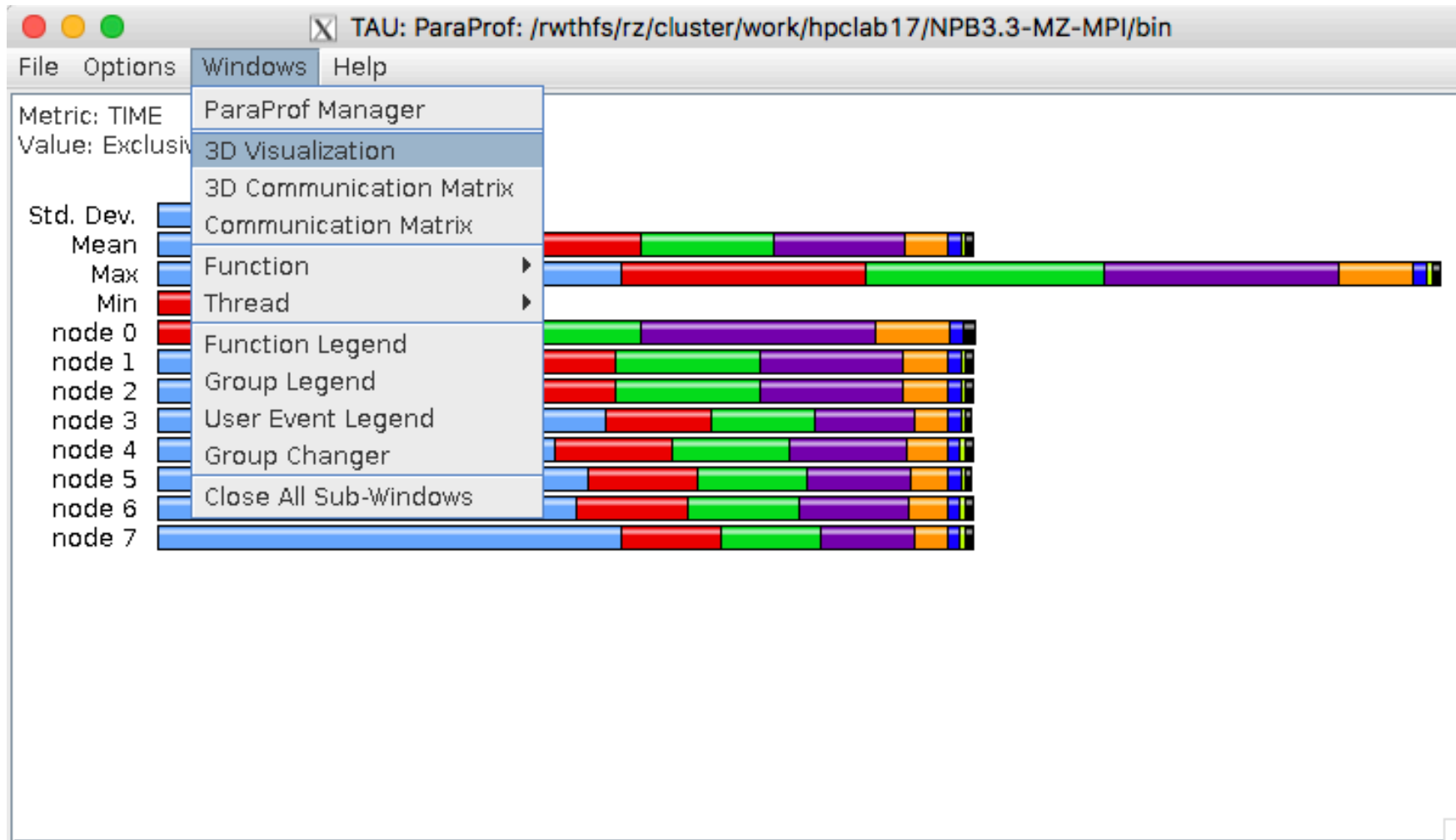

# 3D Visualization with ParaProf

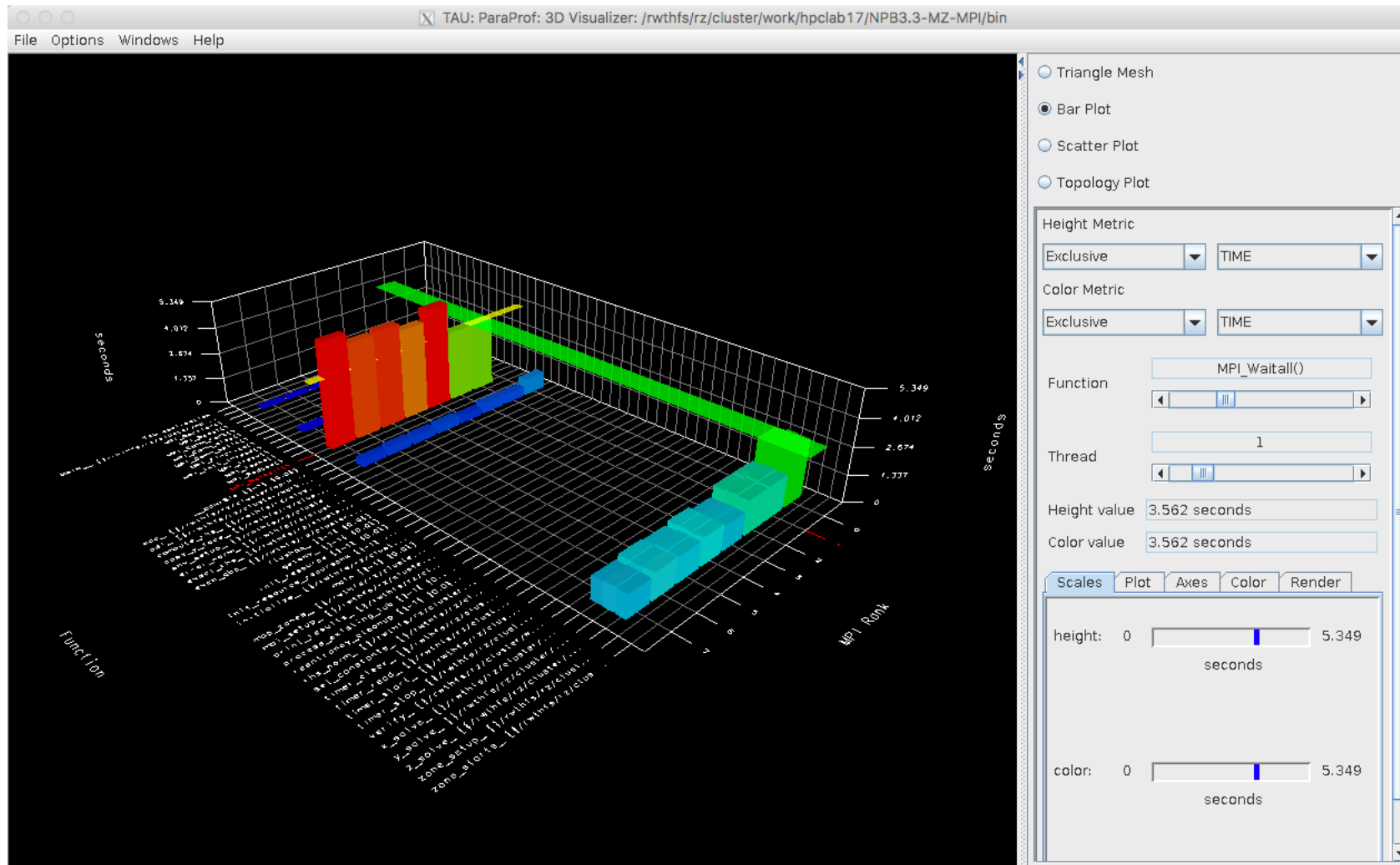



# ParaProf: Node 0

- Optimized
- instrumentation!

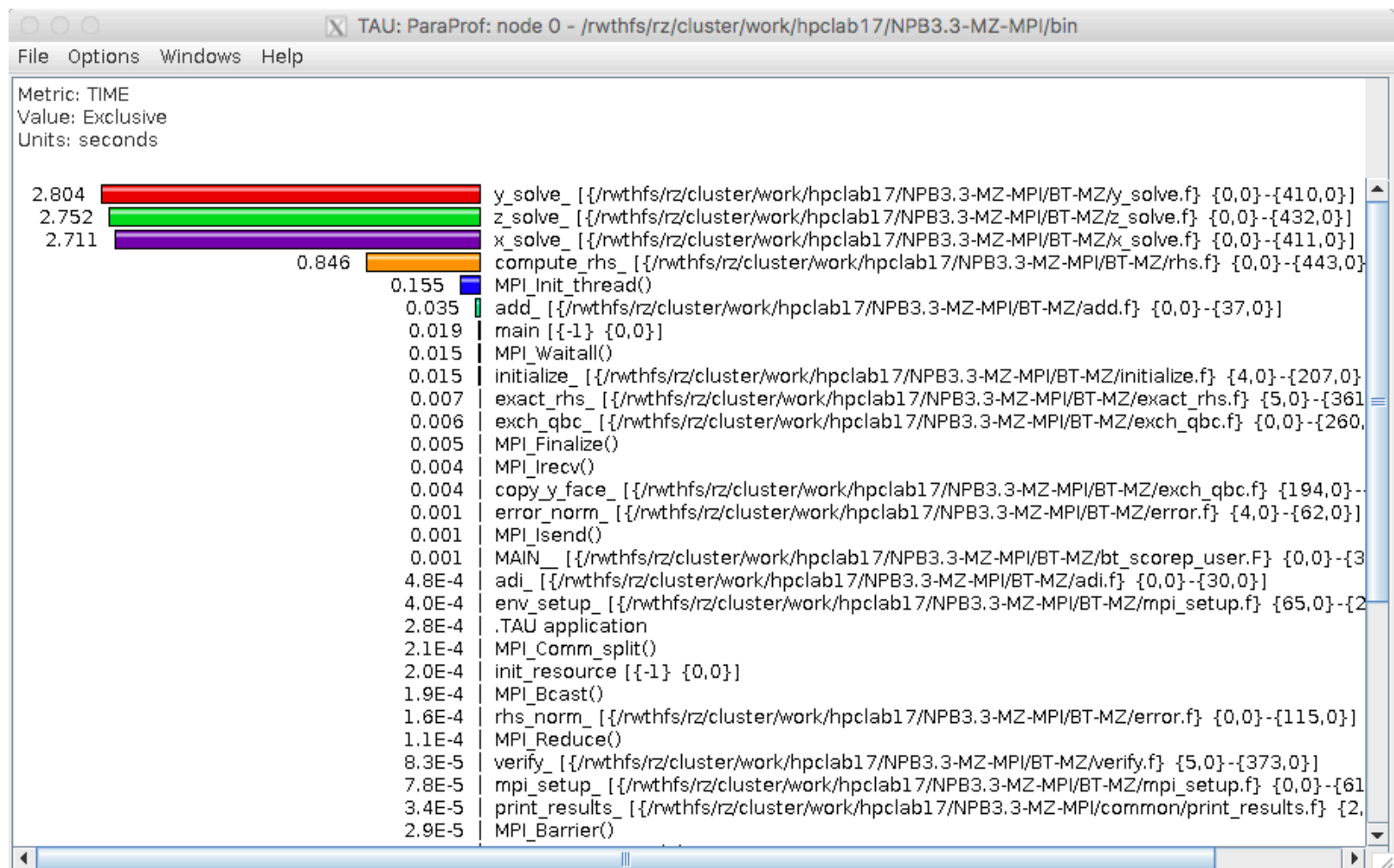



# Source Instrumentation

# TAU's Static Analysis System: Program Database Toolkit (PDT)

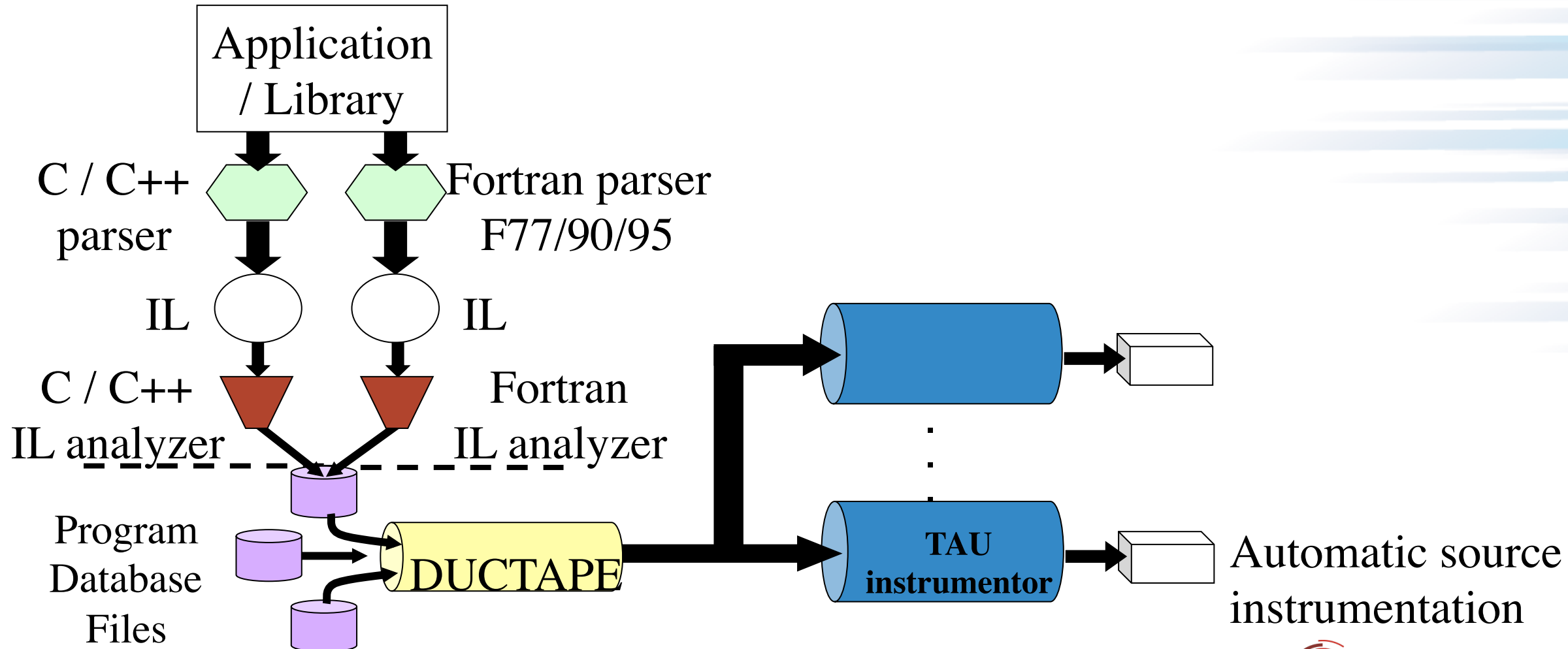

# PDT: automatic source instrumentation

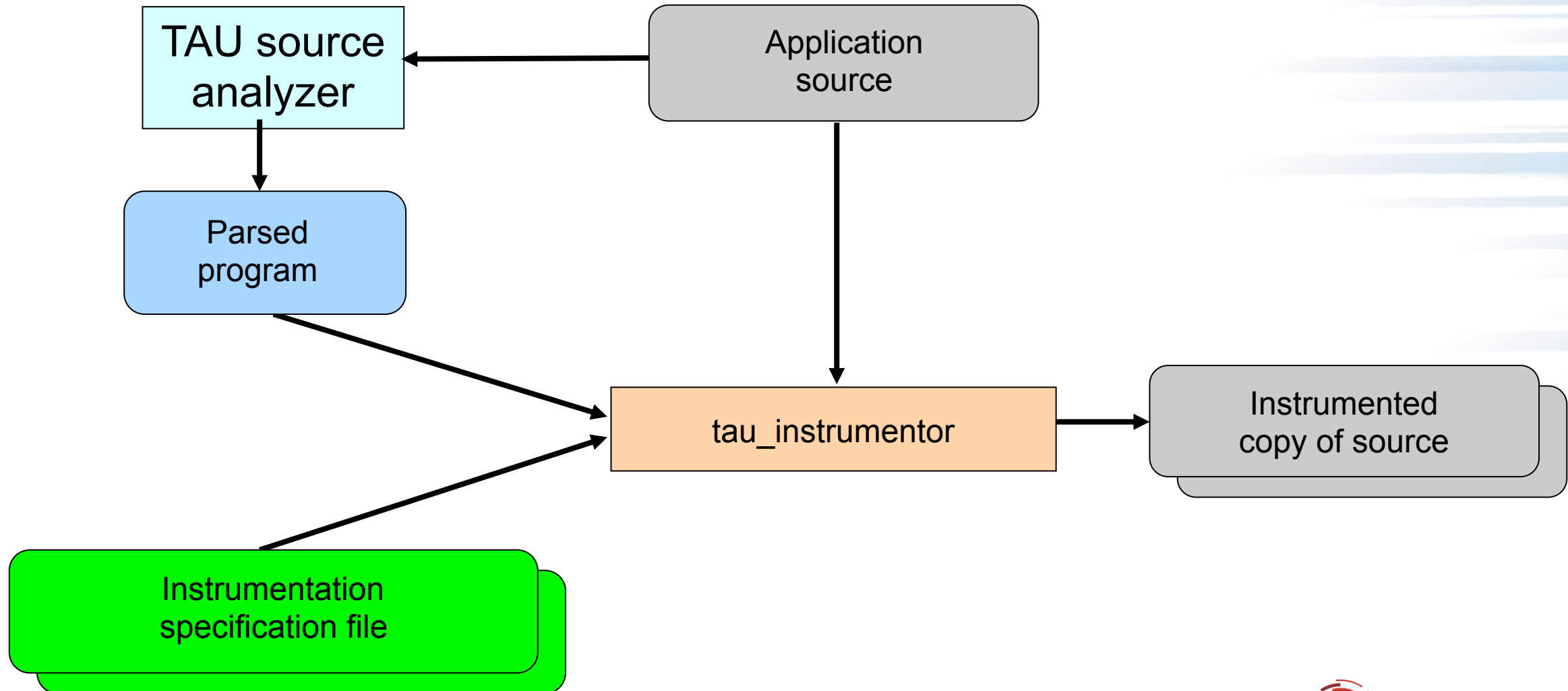

# Using SOURCE Instrumentation in TAU

- TAU supports several compilers, measurement, and thread options

Intel compilers, profiling with hardware counters using PAPI, MPI library, OpenMP...

Each measurement configuration of TAU corresponds to a unique stub makefile (configuration file) and library that is generated when you configure it

- To instrument source code automatically using PDT

Choose an appropriate TAU stub makefile in <arch>/lib:

```
% module load UNITE tau
```

- ```
% export TAU_MAKEFILE=$TAU/Makefile.tau-intel-papi-mpi-pdt
```

```
% export TAU_OPTIONS= '-optVerbose ...' (see tau_compiler.sh )
```

Use tau_f90.sh, tau_cxx.sh, tau_upc.sh, or tau_cc.sh as F90, C++, UPC, or C compilers respectively:

```
% ftn      foo.f90    changes to
```

```
% tau_f90.sh foo.f90
```

- Set runtime environment variables. execute application and analyze performance data:

Installing TAU

- Installing PDT:
 - `wget http://tau.uoregon.edu/pdt_lite.tgz`
 - `./configure --prefix=<dir>; make ; make install`
- Installing TAU on Theta:
 - `wget http://tau.uoregon.edu/tau.tgz`
 - `./configure -arch=craycnl -mpi -pdt=<dir> -bfd=download --unwind=download --iowrapper;`
 - `make install`
 - For x86_64 clusters running Linux
 - `./configure -c++=mpicxx --cc=mpicc --fortran=mpif90 -pdt=<dir> -bfd=download --unwind=download`
 - `make install`
- Using TAU:
 - `export TAU_MAKEFILE=<taudir>/x86_64/lib/Makefile.tau-<TAGS>`
 - `make CC=tau_cc.sh CXX=tau_cxx.sh F90=tau_f90.sh`

INSTALLING TAU on Laptops

- Installing TAU under Mac OS X:
 - `wget http://tau.uoregon.edu/tau.dmg`
 - Install tau.dmg
- Installing TAU under Windows
 - <http://tau.uoregon.edu/tau.exe>
- Installing TAU under Linux
 - <http://tau.uoregon.edu/tau.tgz>
 - `./configure; make install`
 - `export PATH=<taudir>/x86_64/bin:$PATH`

Different Makefiles for TAU Compiler

```
% module load tau
% ls $TAU/Makefile.*
/soft/perf-tools/tau/tau-2.28.2/craycnl/lib/Makefile.tau-gnu-papi-mpi-pdt
/soft/perf-tools/tau/tau-2.28.2/craycnl/lib/Makefile.tau-gnu-papi-mpi-pthread-pdt
/soft/perf-tools/tau/tau-2.28.2/craycnl/lib/Makefile.tau-gnu-papi-pthread-pdt
/soft/perf-tools/tau/tau-2.28.2/craycnl/lib/Makefile.tau-intel-19.0.3.199-papi-mpi-pthread-pdt
/soft/perf-tools/tau/tau-2.28.2/craycnl/lib/Makefile.tau-intel-19.0.3.199-papi-ompt-v5-mpi-pdt-openmp
/soft/perf-tools/tau/tau-2.28.2/craycnl/lib/Makefile.tau-intel-papi-mpi-pdt
/soft/perf-tools/tau/tau-2.28.2/craycnl/lib/Makefile.tau-intel-papi-ompt-tr6-mpi-pdt-openmp
```

For an MPI+OpenMP+F90 application with Intel compilers and Cray MPI, you may choose **Makefile.tau-intel-papi-mpi-pdt**

Supports MPI instrumentation & PDT for automatic source instrumentation

```
% export TAU_MAKEFILE=$TAU/Makefile.tau-intel-papi-mpi-pdt
% tau_f90.sh app.f90 -o app; aprun -n 256 ./app; paraprof
```

Configuration tags for tau_exec

```
% ./configure -pdt=<dir> -mpi -papi=<dir>; make install
```

Creates in \$TAU:

```
Makefile.tau-papi-mpi-pdt (Configuration parameters in stub makefile)  
shared-papi-mpi-pdt/libTAU.so
```

```
% ./configure -pdt=<dir> -mpi; make install creates
```

```
Makefile.tau-mpi-pdt  
shared-mpi-pdt/libTAU.so
```

To explicitly choose preloading of shared-<options>/libTAU.so change:

```
% aprun -n 256 ./a.out to
```

```
% aprun -n 256 tau_exec -T <comma_separated_options> ./a.out
```

```
% aprun -n 256 tau_exec -T papi,mpi,pdt ./a.out
```

Preloads \$TAU/shared-papi-mpi-pdt/libTAU.so

```
% aprun -n 256 tau_exec -T papi ./a.out
```

Preloads \$TAU/shared-papi-mpi-pdt/libTAU.so by matching.

```
% aprun -n 256 tau_exec -T papi,mpi,pdt -s ./a.out
```

Does not execute the program. Just displays the library that it will preload if executed without the -s option.

NOTE: -mpi configuration is selected by default. Use -T serial for Sequential programs.

Compile-Time Options

- Optional parameters for the TAU_OPTIONS environment variable:

% tau_compiler.sh --help

-optVerbose	Turn on verbose debugging messages
-optCompInst	Use compiler based instrumentation
-optNoCompInst	Do not revert to compiler instrumentation if source instrumentation fails.
-optTrackIO	Wrap POSIX I/O call and calculates vol/bw of I/O operations (configure TAU with <i>-iowrapper</i>)
-optTrackGOMP	Enable tracking GNU OpenMP runtime layer (used without <i>-opari</i>)
-optMemDbg	Enable runtime bounds checking (see TAU_MEMDBG_* env vars)
-optKeepFiles	Does not remove intermediate .pdb and .inst.* files
-optPreProcess	Preprocess sources (OpenMP, Fortran) before instrumentation
-optTauSelectFile=" <i><file></i> "	Specify selective instrumentation file for <i>tau_instrumentor</i>
-optTauWrapFile=" <i><file></i> "	Specify path to <i>link_options.tau</i> generated by <i>tau_gen_wrapper</i>
-optHeaderInst	Enable Instrumentation of headers
-optTrackUPCR	Track UPC runtime layer routines (used with tau_upc.sh)
-optLinking=""	Options passed to the linker. Typically $\$(TAU_MPI_FLIBS) \$(TAU_LIBS) \$(TAU_CXXLIBS)$
-optCompile=""	Options passed to the compiler. Typically $\$(TAU_MPI_INCLUDE) \$(TAU_INCLUDE) \$(TAU_DEFS)$
-optPdtF95Opts=""	Add options for Fortran parser in PDT (f95parse/gfparse) ...

Compile-Time Options (contd.)

- Optional parameters for the TAU_OPTIONS environment variable:

% tau_compiler.sh

-optMICOffload	Links code for Intel MIC offloading, requires both host and MIC TAU libraries
-optShared	Use TAU's shared library (libTAU.so) instead of static library (default)
-optPdtCxxOpts=""	Options for C++ parser in PDT (cxxparse).
-optPdtF90Parser=""	Specify a different Fortran parser
-optPdtCleanscapeParser	Specify the Cleanscape Fortran parser instead of GNU gfparser
-optTau=""	Specify options to the tau_instrumentor
-optTrackDMAPP	Enable instrumentation of low-level DMAPP API calls on Cray
-optTrackPthread	Enable instrumentation of pthread calls

See tau_compiler.sh for a full list of TAU_OPTIONS.

Selective Instrumentation File Format

- To use an instrumentation specification file for source instrumentation:

```
% export TAU_OPTIONS= '-optTauSelectFile=/path/to/select.tau -optVerbose '
```

```
% cat select.tau
```

```
BEGIN_EXCLUDE_LIST
```

```
BINVCRHS
```

```
MATMUL_SUB
```

```
MATVEC_SUB
```

```
EXACT_SOLUTION
```

```
LHS#INIT
```

```
TIMER_#
```

```
END_EXCLUDE_LIST
```

NOTE: paraprof can create this file from an earlier execution for you.

File -> Create Selective Instrumentation File -> save

Selective instrumentation at runtime:

```
% export TAU_SELECT_FILE=select.tau
```

Create a Selective Instrumentation File, Re-instrument, Re-run

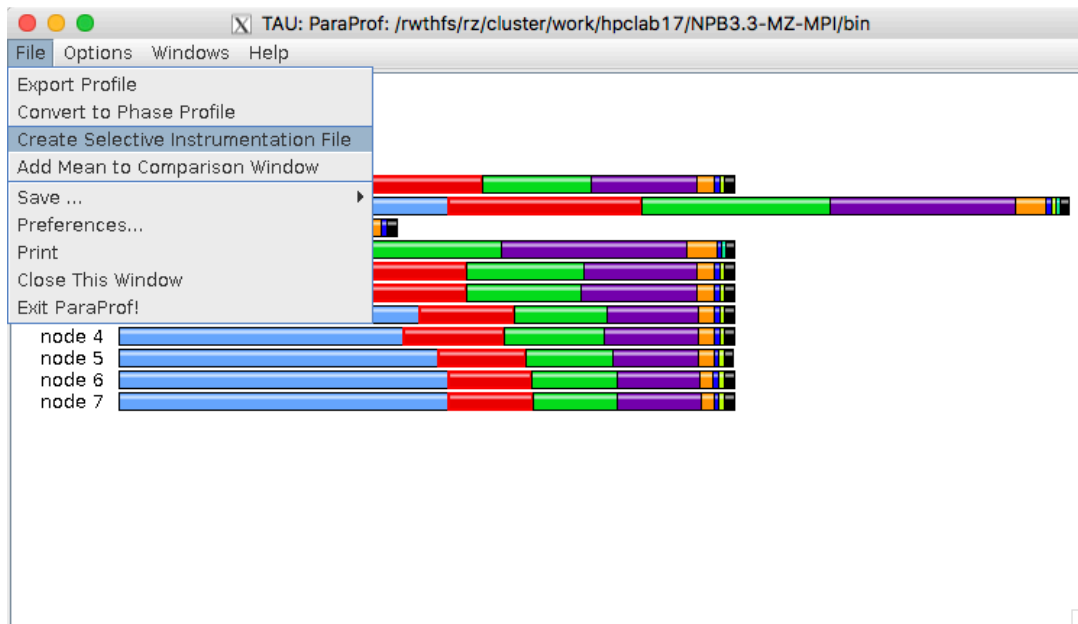

The screenshot shows the "TAU: ParaProf: Selective Instrumentation File Generator" dialog box. The title bar reads "TAU: ParaProf: Selective Instrumentation File Generator". The "Output File:" field contains the path "/rwthfs/rz/cluster/work/hpclub17/NPB3.3-MZ-MPI/bin/select.tau". There are two checked checkboxes: "Exclude Throttled Routines" and "Exclude Lightweight Routines". Under "Lightweight Routine Exclusion Rules", the "Microseconds per call:" field is set to "10" and the "Number of calls:" field is set to "100000". The "Excluded Routines:" list contains the following entries: "lhsinit_", "exact_solution_", "matvec_sub_", "matmul_sub_", "binvrhs_", and "binrhs_". At the bottom, there is a "save" button (highlighted with an orange box), a checked "Merge" checkbox, and a "close" button.



Advanced MPI Performance Engineering



MVAPICH2 and TAU

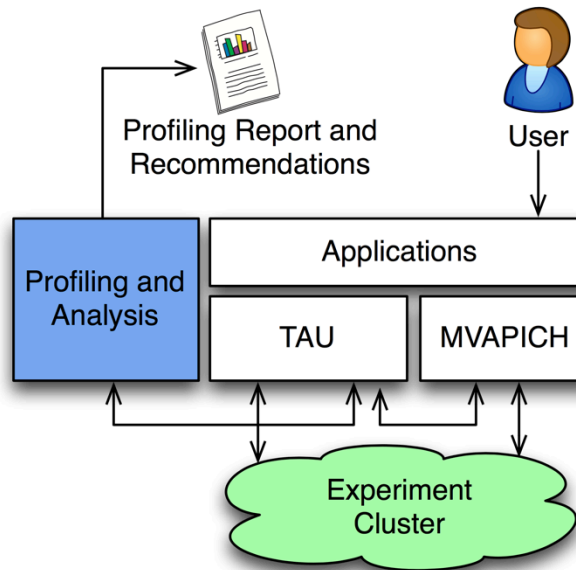

- TAU and MVAPICH2 are enhanced with the ability to generate recommendations and engineering performance report
- MPI libraries like MVAPICH2 are now “reconfigurable” at runtime
- TAU and MVAPICH2 communicate using the MPI-T interface

Interfacing TAU and MVAPICH2 through MPI_T Interface

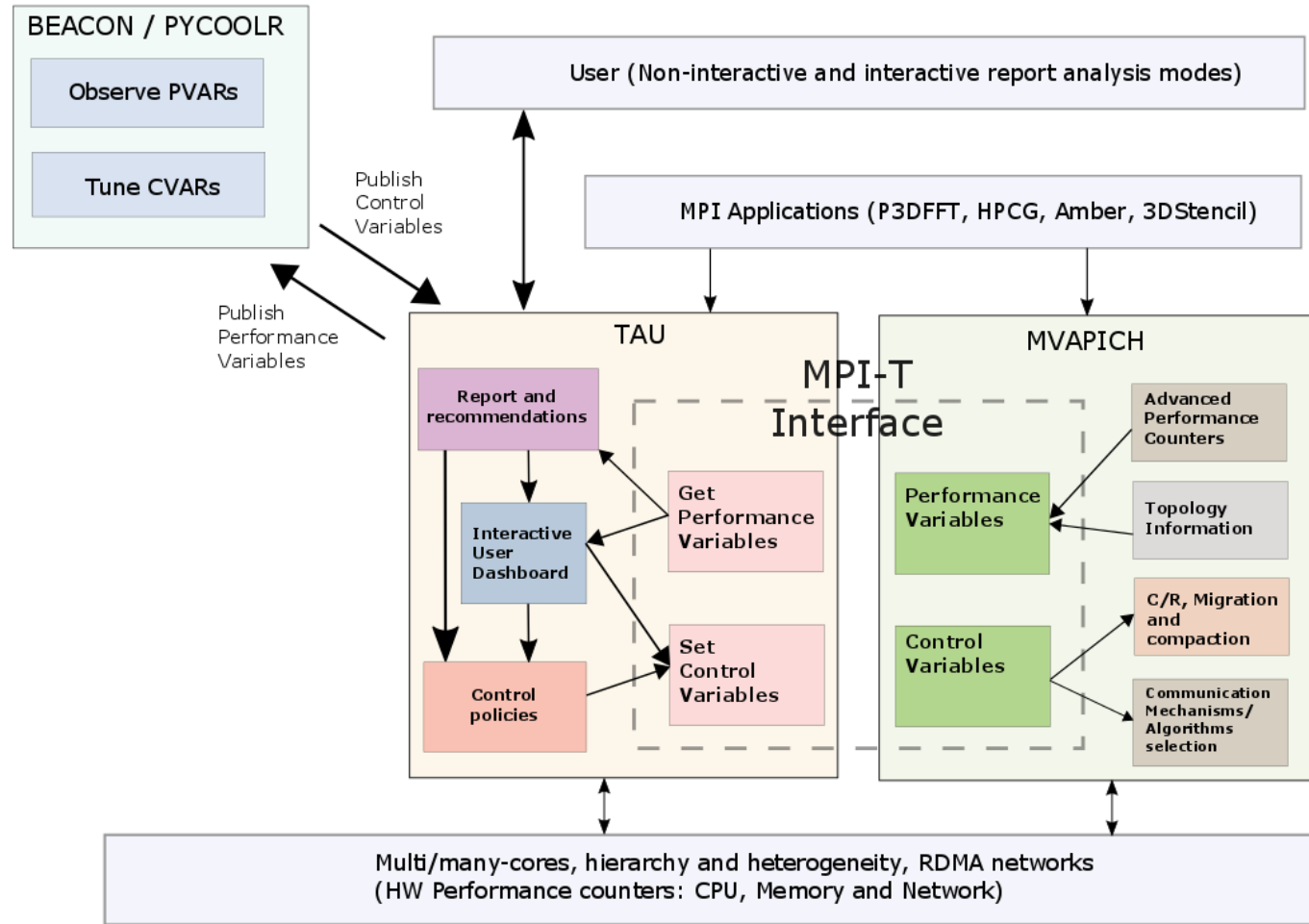

- Enhance existing support for MPI_T in MVAPICH2 to expose a richer set of performance and control variables
- Get and display MPI Performance Variables (PVARs) made available by the runtime in TAU
- Control the runtime's behavior via MPI Control Variables (CVARs)
- Add support to MVAPICH2 and TAU for interactive performance engineering sessions

Plugin-based Infrastructure for Non-Interactive Tuning

- Performance data collected by TAU
 - Support for PVARs and CVARs
 - Setting CVARs to control MVAPICH2
 - Studying performance data in TAU's ParaProf profile browser
- Multiple plugins available for
 - Tuning application at runtime and
 - Generate post-run recommendations

Srinivasan Ramesh, Aurele Maheo, Sameer Shende, Allen D. Malony, Hari Subramoni, and Dhabaleswar K. Panda. "MPI performance engineering with the MPI tool interface: the integration of MVAPICH and TAU." Proceedings of the 24th European MPI Users Group Meeting (EuroMPI/USA). 2017.

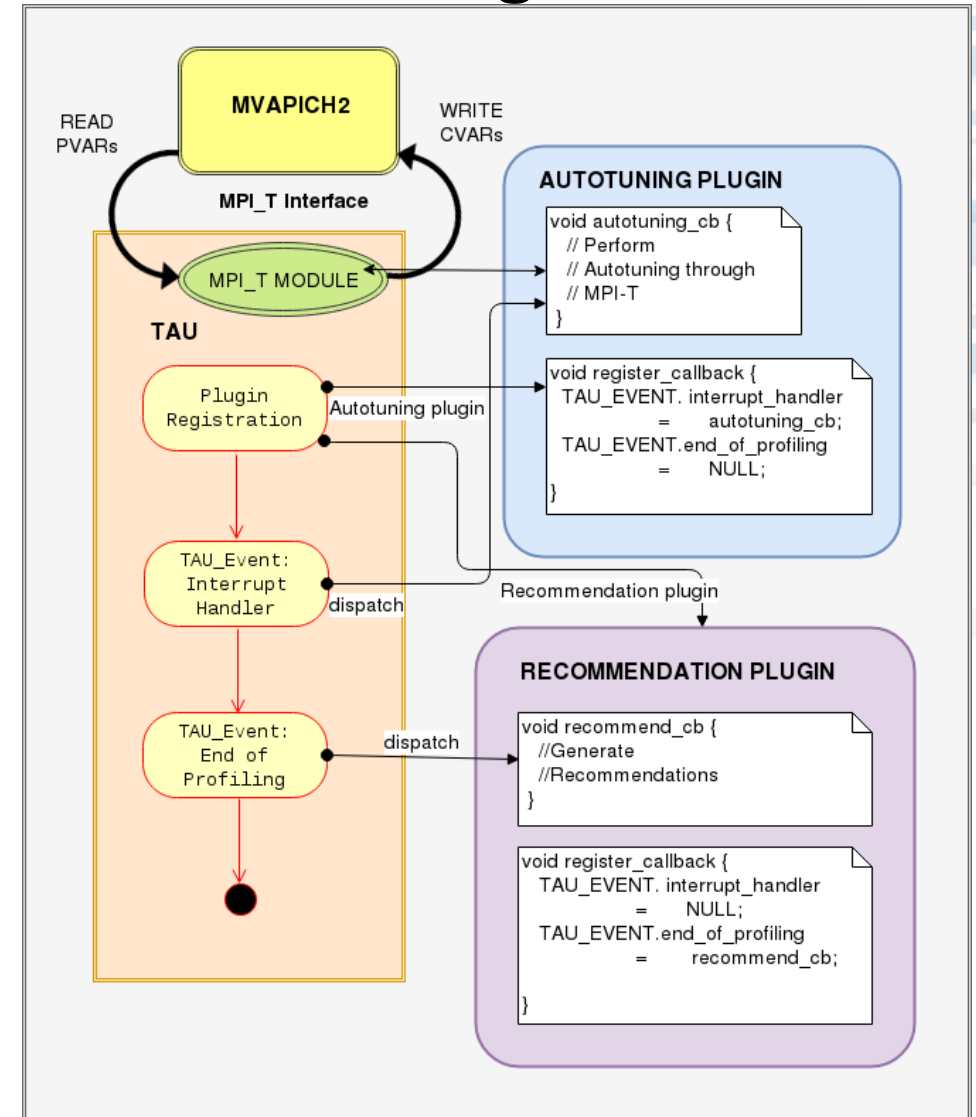

Using MVAPICH2 and TAU

- To set CVARs or read PVARs using TAU for an uninstrumented binary:
% export TAU_TRACK_MPI_T_PVARS=1
% export TAU_MPI_T_CVAR_METRICS=
 MPIR_CVAR_VBUF_POOL_REDUCED_VALUE[1],
 MPIR_CVAR_IBA_EAGER_THRESHOLD
% export TAU_MPI_T_CVAR_VALUES=32,64000
% export PATH=/path/to/tau/x86_64/bin:\$PATH
% mpirun -np 1024 *tau_exec -T mvapich2,mpit* ./a.out
% paraprof

Optimizing Memory Usage in MPI using MPI_T CVARs

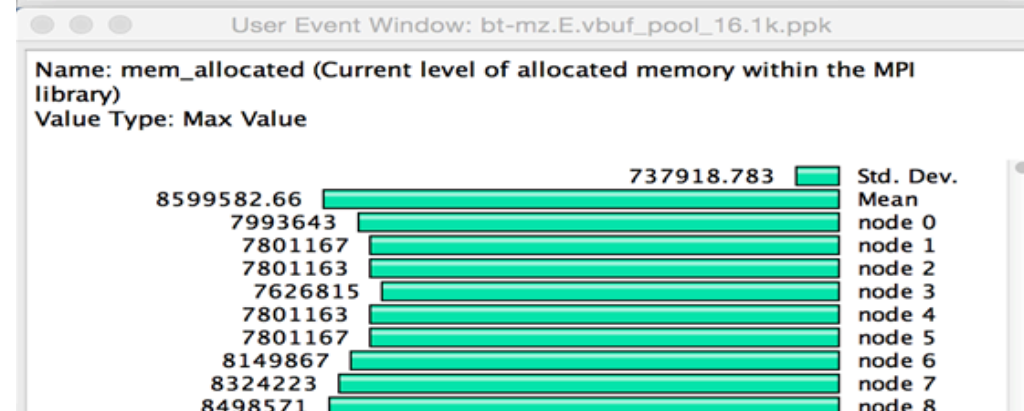
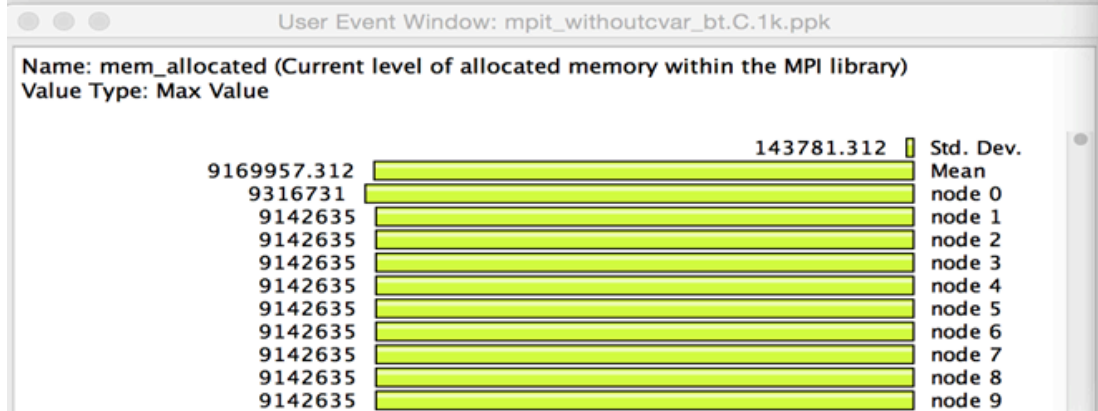
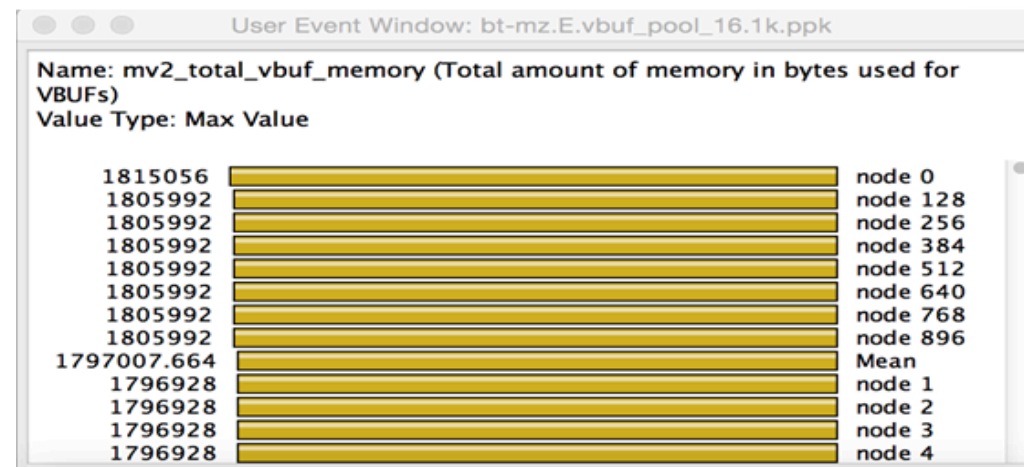
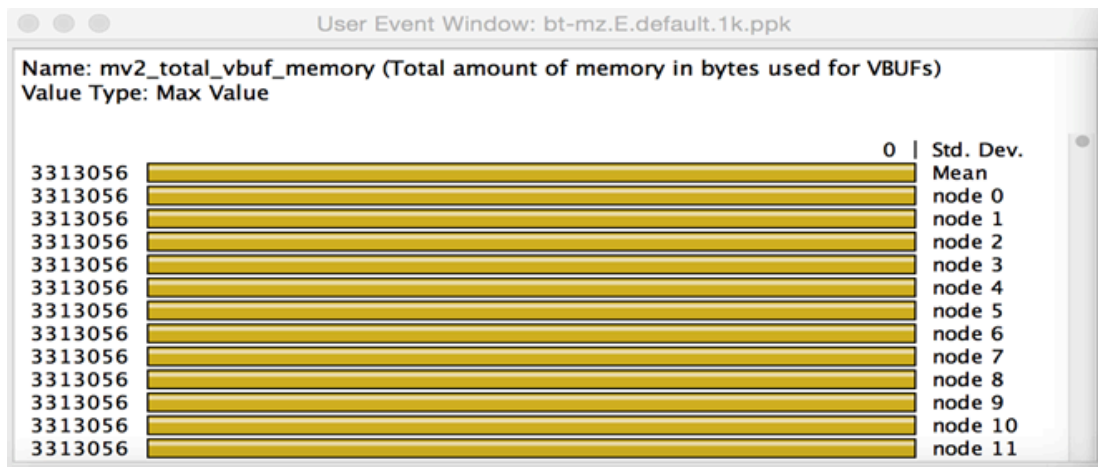

```
% export TAU_TRACK_MPI_T_PVARS=1
% export TAU_MPI_T_CVAR_METRICS=MPIR_CVAR_VBUF_POOL_SIZE
% export TAU_MPI_T_CVAR_VALUES=16
% mpirun -np 1024 tau_exec -T mvapich2,mpit .la.out
```

Usage Scenarios with MVAPICH2 and TAU

- TAU measures the high water mark of total memory usage (TAU_TRACK_MEMORY_FOOTPRINT=1), finds that it is at 98% of available memory, and queries MVAPICH2 to find out how much memory it is using. Based on the number of pools allocated and used, it requests it to reduce the number of VBUF pools and controls the size of these pools using the MPI-T interface. The total memory footprint of the application reduces.
- TAU tracks the message sizes of messages (TAU_COMM_MATRIX=1), detects excessive time spent in MPI_Wait and other synchronization operations. It compares the average message size with the eager threshold and sets the new eager threshold value to match the message size. This could be done offline by re-executing the application with the new CVAR setting for eager threshold or online.
- TAU uses Beacon (backplane for event and control notification) to observe the performance of a running application (for e.g., vbuf pool statistics, high water mark of total and vbuf memory usage, message size statistics).

Introspecting Impact of Eager Threshold on 3D Stencil Benchmark

Default

Optimized

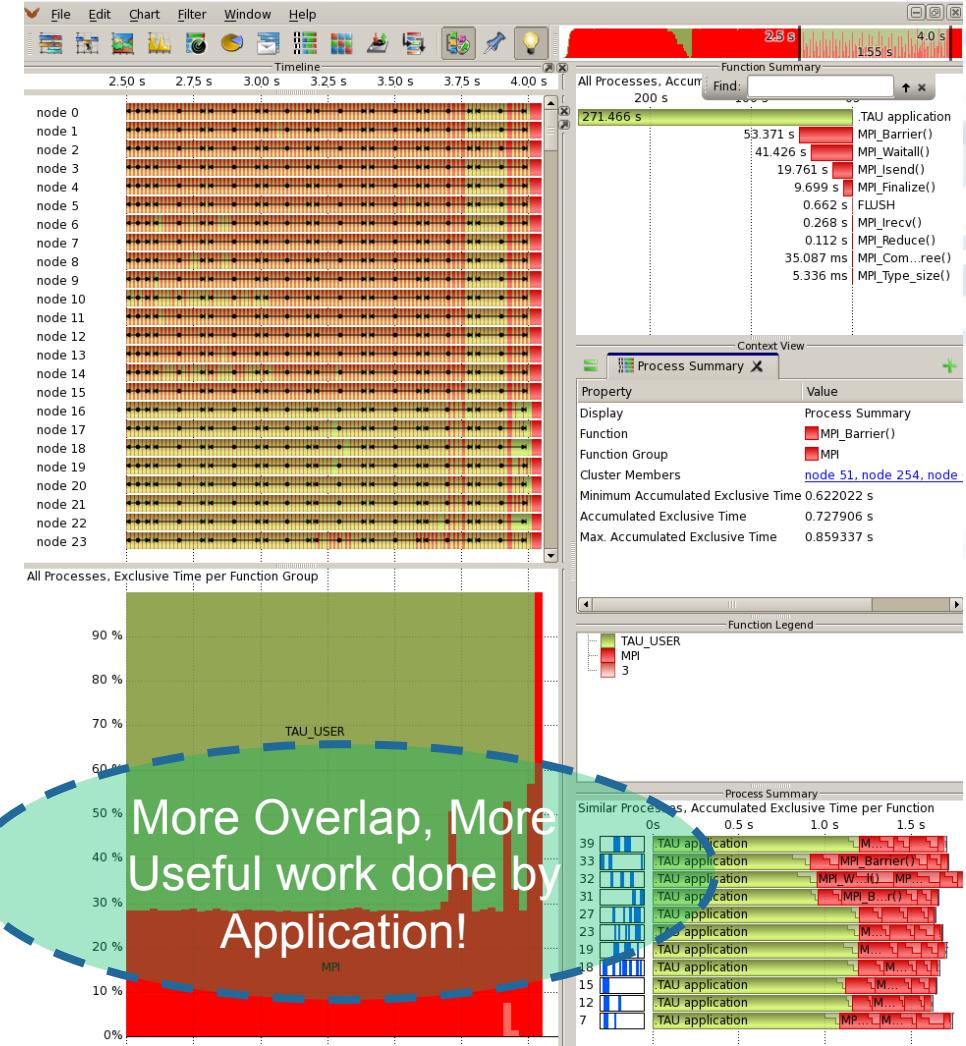
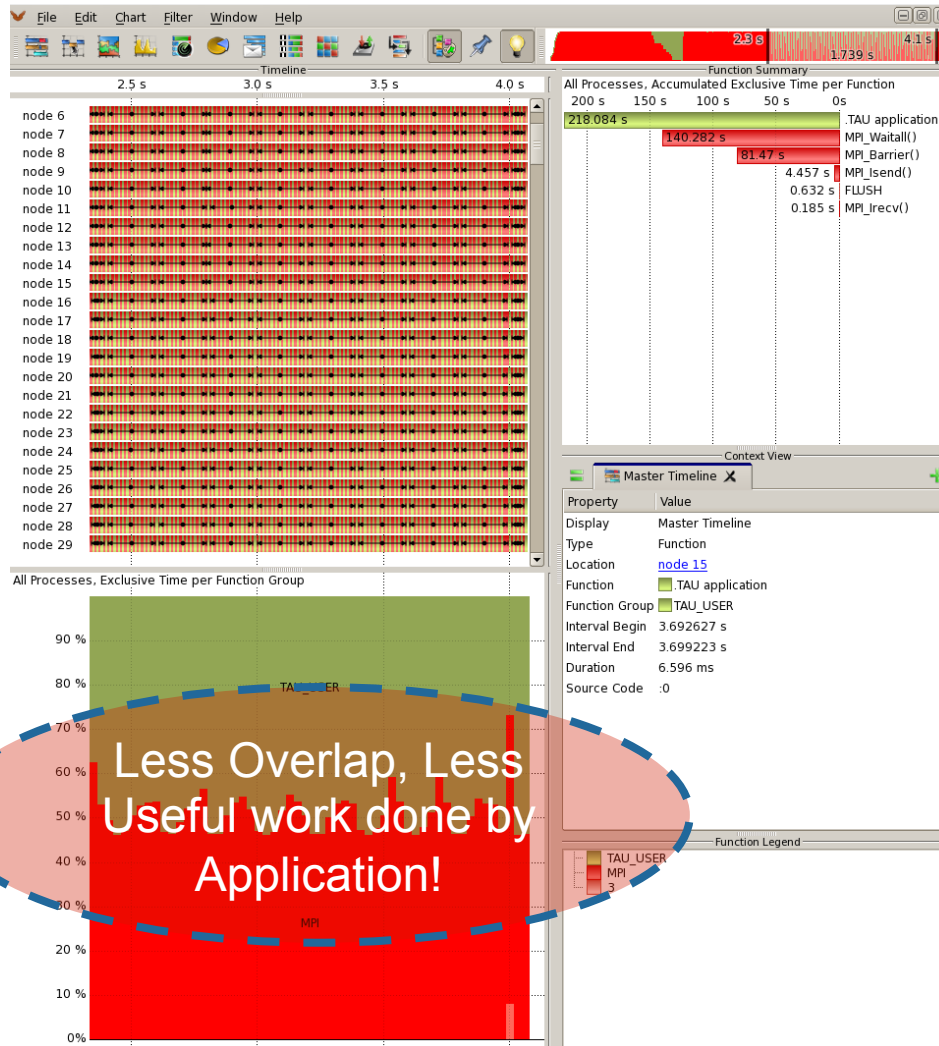



TAU Commander



TAU Commander's Approach

- Say where you're going, not how to get there
- **Experiments** give **context** to the user's actions
 - Defines desired metrics and measurement approach
 - Defines operating environment
 - Establishes a baseline for error checking

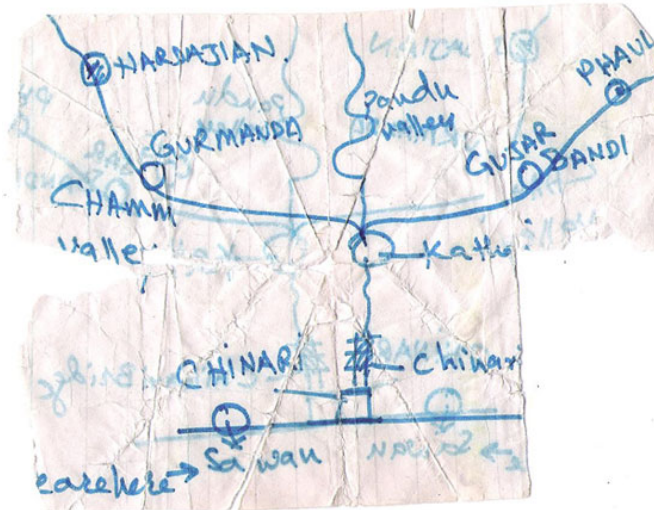

VS.



Getting Started with TAU Commander

1. **tau** initialize
 2. **tau** ftn*.f90 -o foo
 3. **tau** aprun -n 64 ./foo
 4. **tau** show
 5. **tau --help**
 6. **tau show --help**
- This works on any supported system, even if TAU is not installed or has not been configured appropriately.
 - TAU and all its dependencies will be downloaded and installed if required.
 - <http://www.taucommander.com>
 - BSD Style license. GitHub:
 - <https://github.com/ParaToolsInc/taucmdr>

TAU Commander online help

```
jlinford — ssh cori.nersc.gov — 80x47
jlinford@cori09 ~/workspace/openshmem17/applications/ISx $ tau --help
usage: tau [arguments] <subcommand> [options]

TAU Commander 1.0a [ www.taucommander.com ]

Positional Arguments:
<subcommand> See subcommand descriptions below.
[options] Options to be passed to <subcommand>.

Optional Arguments:
-V, --version Show program's version number and exit.
-h, --help Show this help message and exit.
-q, --quiet Suppress all output except error messages.
-v, --verbose Show debugging messages.

Configuration Subcommands:
application Create and manage application configurations.
experiment Create and manage experiments.
measurement Create and manage measurement configurations.
project Create and manage project configurations.
target Create and manage target configurations.
trial Create and manage experiment trials.

Subcommands:
build Instrument programs during compilation and/or linking.
configure Configure TAU Commander.
dashboard Show all project components.
help Show help for a command or suggest actions for a file.
initialize Initialize TAU Commander.
select Create a new experiment or select an existing experiment.

Shortcuts:
tau <compiler> Execute a compiler command
- Example: tau gcc *.c -o a.out
- Alias for 'tau build <compiler>'
tau <program> Gather data from a program
- Example: tau ./a.out
- Alias for 'tau trial create <program>'
tau metrics Show metrics available in the current experiment
- Alias for 'tau target metrics'
tau select Select configuration objects to create a new experiment
- Alias for 'tau experiment create'
tau show Show data from the most recent trial
- Alias for 'tau trial show'

See 'tau help <subcommand>' for more information on <subcommand>.
jlinford@cori09 ~/workspace/openshmem17/applications/ISx $
```

```
jlinford — ssh cori.nersc.gov — 80x35
jlinford@cori09 ~/workspace/openshmem17/applications/ISx $ tau app cre --help
usage: tau application create <application_name> [arguments]

Create application configurations.

Optional Arguments:
-@ <level> Create the application at the specified storage
level.
- <level>: project, user, system
- default: project
-h, --help Show this help message and exit.

Application Arguments:
<application_name> Application configuration name.
--cuda [T/F] Application uses NVIDIA CUDA.
- default: False
--linkage <linkage> Application linkage.
- <linkage>: static, dynamic
- default: static
--mpc [T/F] Application uses MPC.
- default: False
--mpi [T/F] Application uses MPI.
- default: False
--opencl [T/F] Application uses OpenCL.
- default: False
--openmp [T/F] Application uses OpenMP.
- default: False
--pthreads [T/F] Application uses pthreads.
- default: False
--select-file path Specify selective instrumentation file.
--shmem [T/F] Application uses SHMEM.
- default: False
--tbb [T/F] Application uses Thread Building Blocks (TBB).
- default: False
jlinford@cori09 ~/workspace/openshmem17/applications/ISx $
```

Installing and Configuring TAU

•Installing PDT:

- `wget tau.uoregon.edu/pdt_lite.tgz`
- `./configure --prefix=<dir>; make ; make install`

•Installing TAU:

- `wget tau.uoregon.edu/tau.tgz; tar zxf tau.tgz; cd tau-2.<ver>`
- `wget http://tau.uoregon.edu/ext.tgz ; tar xf ext.tgz`
- `./configure -bfd=download -pdt=<dir> -papi=<dir> -mpi
-pthread -c++=mpicxx -cc=mpicc -fortran=mpif90
-dwarf=download -unwind=download -otf=download
-iowrapper -papi=<dir>`
- `make install`

•Using TAU:

- `export TAU_MAKEFILE=<taudir>/x86_64/lib/Makefile.tau-<TAGS>`
- `make CC=tau_cc.sh CXX=tau_cxx.sh F90=tau_f90.sh`

Compile-Time Options

•Optional parameters for the TAU_OPTIONS environment variable:

% tau_compiler.sh

- optVerbose Turn on verbose debugging messages
- optCompInst Use compiler based instrumentation
- optNoCompInst Do not revert to compiler instrumentation if source instrumentation fails.
- optTrackIO Wrap POSIX I/O call and calculates vol/bw of I/O operations configured with *-iowrapper*
- optTrackGOMP Enable tracking GNU OpenMP runtime layer (used without *-opari*)
- optMemDbg Enable runtime bounds checking (see TAU_MEMDBG_* env vars)
- optKeepFiles Does not remove intermediate .pdb and .inst.* files
- optPreProcess Preprocess sources (OpenMP, Fortran) before instrumentation
- optTauSelectFile="*<file>*" Specify selective instrumentation file for *tau_instrumentor*
- optTauWrapFile="*<file>*" Specify path to *link_options.tau* generated by *tau_gen_wrapper*
- optHeaderInst Enable Instrumentation of headers
- optTrackUPCR Track UPC runtime layer routines (used with tau_upc.sh)
- optLinking="" Options passed to the linker. Typically \$(TAU_MPI_FLIBS) \$(TAU_LIBS) \$(TAU_CXXLIBS)
- optCompile="" Options passed to the compiler. Typically \$(TAU_MPI_INCLUDE) \$(TAU_INCLUDE) \$(TAU_DEFS)
- optPdtF95Opts="" Add options for Fortran parser in PDT (f95parse/gfparse) ...

(Requires TAU to be

Compile-Time Options (contd.)

•Optional parameters for the TAU_OPTIONS environment variable:

% tau_compiler.sh

- optShared Use TAU's shared library (libTAU.so) instead of static library (default)
- optPdtCxxOpts="" Options for C++ parser in PDT (cxxparse).
- optPdtF90Parser="" Specify a different Fortran parser
- optPdtCleanscapeParser Specify the Cleanscape Fortran parser instead of GNU gfparser
- optTau="" Specify options to the tau_instrumentor
- optTrackDMAPP Enable instrumentation of low-level DMAPP API calls on Cray
- optTrackPthread Enable instrumentation of pthread calls

See tau_compiler.sh for a full list of TAU_OPTIONS.

...

TAU's Runtime Environment Variables

Environment Variable	Default	Description
TAU_TRACE	0	Setting to 1 turns on tracing
TAU_CALLPATH	0	Setting to 1 turns on callpath profiling
TAU_TRACK_MEMORY_FOOTPRINT	0	Setting to 1 turns on tracking memory usage by sampling periodically the resident set size and high water mark of memory usage
TAU_TRACK_POWER	0	Tracks power usage by sampling periodically.
TAU_CALLPATH_DEPTH	2	Specifies depth of callpath. Setting to 0 generates no callpath or routine information, setting to 1 generates flat profile and context events have just parent information (e.g., Heap Entry: foo)
TAU_SAMPLING	1	Setting to 1 enables event-based sampling.
TAU_TRACK_SIGNALS	0	Setting to 1 generate debugging callstack info when a program crashes
TAU_COMM_MATRIX	0	Setting to 1 generates communication matrix display using context events
TAU_THROTTLE	1	Setting to 0 turns off throttling. Throttles instrumentation in lightweight routines that are called frequently
TAU_THROTTLE_NUMCALLS	100000	Specifies the number of calls before testing for throttling
TAU_THROTTLE_PERCALL	10	Specifies value in microseconds. Throttle a routine if it is called over 100000 times and takes less than 10 usec of inclusive time per call
TAU_CALLSITE	0	Setting to 1 enables callsite profiling that shows where an instrumented function was called. Also compatible with tracing.
TAU_PROFILE_FORMAT	Profile	Setting to "merged" generates a single file. "snapshot" generates xml format
TAU_METRICS	TIME	Setting to a comma separated list generates other metrics. (e.g., ENERGY,TIME,P_VIRTUAL_TIME,PAPI_FP_INS,PAPI_NATIVE_<event>:<subevent>)

Runtime Environment Variables

Environment Variable	Default	Description
TAU_TRACE	0	Setting to 1 turns on tracing
TAU_TRACE_FORMAT	Default	Setting to "otf2" turns on TAU's native OTF2 trace generation (configure with <code>-otf=download</code>)
TAU_EBS_UNWIND	0	Setting to 1 turns on unwinding the callstack during sampling (use with <code>tau_exec -ebs</code> or <code>TAU_SAMPLING=1</code>)
TAU_EBS_RESOLUTION	line	Setting to "function" or "file" changes the sampling resolution to function or file level respectively.
TAU_TRACK_LOAD	0	Setting to 1 tracks system load on the node
TAU_SELECT_FILE	Default	Setting to a file name, enables selective instrumentation based on exclude/include lists specified in the file.
TAU_OMPT_SUPPORT_LEVEL	basic	Setting to "full" improves resolution of OMPT TR6 regions on threads 1.. N-1. Also, "lowoverhead" option is available.
TAU_OMPT_RESOLVE_ADDRESS_EAGERLY	1	Setting to 1 is necessary for event based sampling to resolve addresses with OMPT. Setting to 0 allows the user to do offline address translation.

Runtime Environment Variables

Environment Variable	Default	Description
TAU_TRACK_MEMORY_LEAKS	0	Tracks allocates that were not de-allocated (needs <code>-optMemDbg</code> or <code>tau_exec -memory</code>)
TAU_EBS_SOURCE	TIME	Allows using PAPI hardware counters for periodic interrupts for EBS (e.g., <code>TAU_EBS_SOURCE=PAPI_TOT_INS</code> when <code>TAU_SAMPLING=1</code>)
TAU_EBS_PERIOD	100000	Specifies the overflow count for interrupts
TAU_MEMDBG_ALLOC_MIN/MAX	0	Byte size minimum and maximum subject to bounds checking (used with <code>TAU_MEMDBG_PROTECT_*</code>)
TAU_MEMDBG_OVERHEAD	0	Specifies the number of bytes for TAU's memory overhead for memory debugging.
TAU_MEMDBG_PROTECT_BELOW/ABOVE	0	Setting to 1 enables tracking runtime bounds checking below or above the array bounds (requires <code>-optMemDbg</code> while building or <code>tau_exec -memory</code>)
TAU_MEMDBG_ZERO_MALLOC	0	Setting to 1 enables tracking zero byte allocations as invalid memory allocations.
TAU_MEMDBG_PROTECT_FREE	0	Setting to 1 detects invalid accesses to deallocated memory that should not be referenced until it is reallocated (requires <code>-optMemDbg</code> or <code>tau_exec -memory</code>)
TAU_MEMDBG_ATTEMPT_CONTINUE	0	Setting to 1 allows TAU to record and continue execution when a memory error occurs at runtime.
TAU_MEMDBG_FILL_GAP	Undefined	Initial value for gap bytes
TAU_MEMDBG_ALINGMENT	Sizeof(int)	Byte alignment for memory allocations
TAU_EVENT_THRESHOLD	0.5	Define a threshold value (e.g., .25 is 25%) to trigger marker events for min/max

Download TAU from U. Oregon

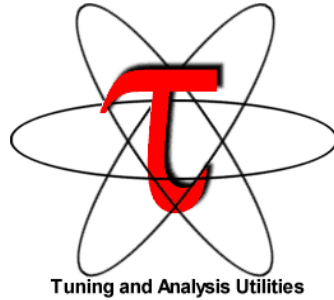

<http://tau.uoregon.edu>

<http://taucommander.com>

<http://www.hpclinux.com> [OVA for VirtualBox]

<https://e4s.io> [Extreme-Scale Scientific Software Stack,
Containers for HPC]

for more information

Free download, open source, BSD license



PRL, University of Oregon, Eugene



Support Acknowledgements

- US Department of Energy (DOE)
 - ANL
 - Office of Science contracts, ECP
 - SciDAC, LBL contracts
 - LLNL-LANL-SNL ASC/NNSA contract
 - Battelle, PNNL and ORNL contract
- Department of Defense (DoD)
 - PETTT, HPCMP
- National Science Foundation (NSF)
 - SI2-SSI, Glassbox
- NASA
- CEA, France
- Partners:
 - University of Oregon
 - The Ohio State University
 - ParaTools, Inc.
 - University of Tennessee, Knoxville
 - T.U. Dresden, GWT
 - Jülich Supercomputing Center



Acknowledgement

This research was supported by the Exascale Computing Project (17-SC-20-SC), a collaborative effort of two U.S. Department of Energy organizations (Office of Science and the National Nuclear Security Administration) responsible for the planning and preparation of a capable exascale ecosystem, including software, applications, hardware, advanced system engineering, and early testbed platforms, in support of the nation's exascale computing imperative.